

Clean Service

Safety Relief Valves
Series 48X



CATALOG

LESER

The-Safety-Valve.com

Product group

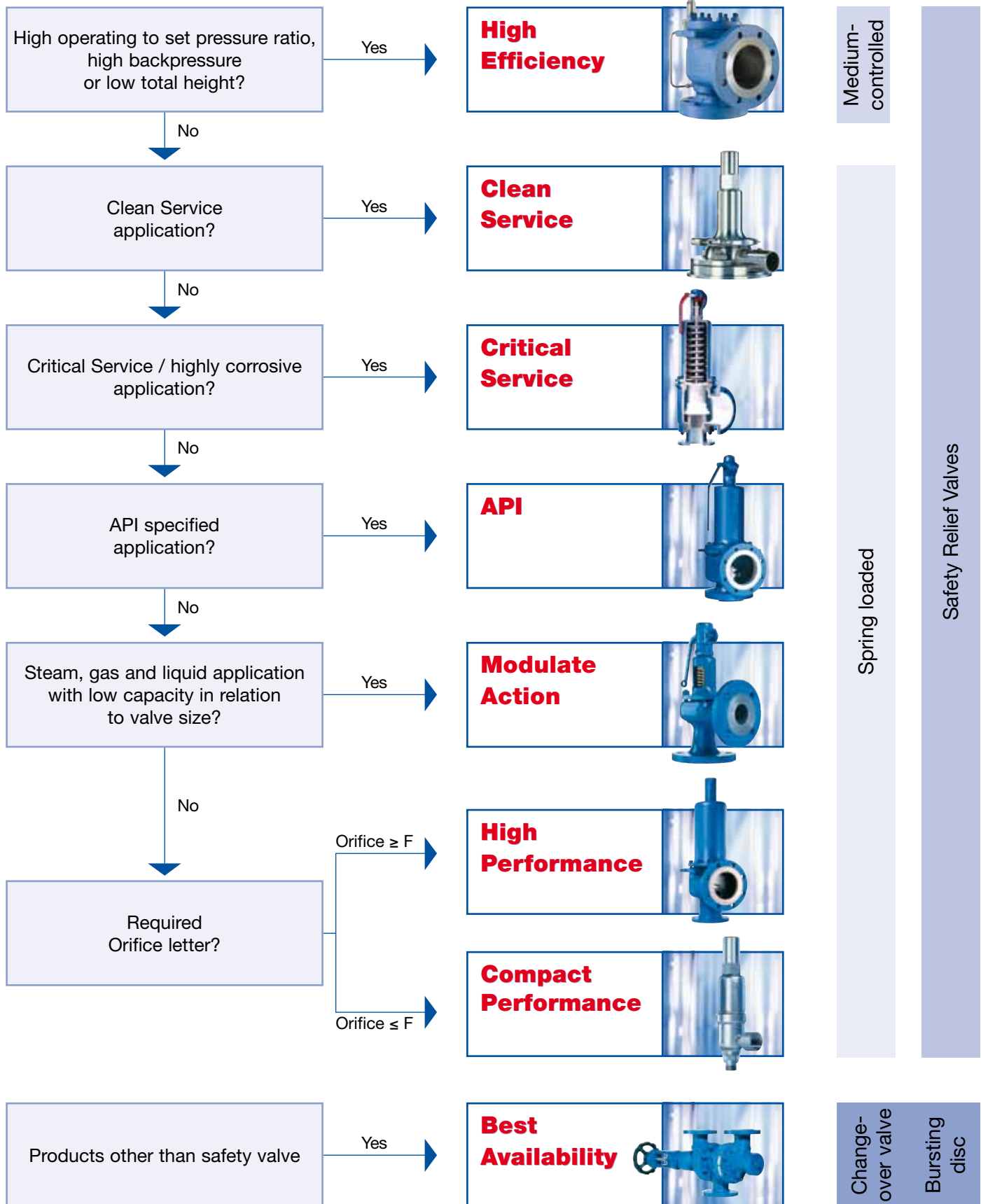

How to select the right Clean Service Safety Valve

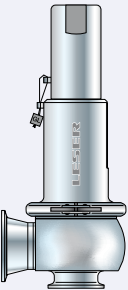
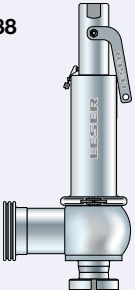
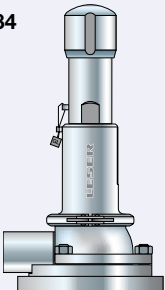
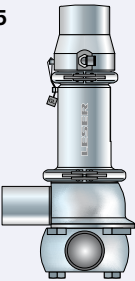
	Type	Orifice	Features	Valve dead space ratio ¹⁾	Description
Standard	481 	0,5 x D	Cleanability Inlet Cleanability Outlet Capacity 	L/D < 1,5	Designed for small capacity; Type 481 offers protection for installations in which Clean Service properties are required only at the valve inlet, e. g. protection of gas systems for the bottling of beverages.
	483 	D – F	Cleanability Inlet Cleanability Outlet Capacity 	L/D < 1,5	Designed for small to medium capacity; Type 483 has optimized Clean Service properties for applications requiring clamp connections. Type 483 is applicable in all Clean Service areas (e. g. bottle filling machines, fermenters).
	488 	G – P	Cleanability Inlet Cleanability Outlet Capacity 	L/D < 1,5 – 3,0	Designed for high capacity; Type 488 provides Clean Service properties for applications requiring larger capacities. Type 488 is applicable in large plants, breweries and the beverage industry.
Superior	484 	D – F	Cleanability Inlet Cleanability Outlet Capacity 	L/D < 0,33	Designed for small to medium capacity; Type 484 meets the highest sanitary requirements for high purity applications, e. g. fermentors. The design incorporates a dead space free vessel connection, which is directly welded into the vessel wall and allows maximum cleanability of the valve inlet.
	485 	D – F	Cleanability Inlet Cleanability Outlet Capacity 	L/D < 0,95	Designed for small to medium capacity; Type 485 meets the highest sanitary requirements for high purity applications, e. g. fermentors. The design incorporates a dead space free pipe connection, which is directly welded into the pipework and allows maximum cleanability of the valve inlet. Type 485 can be used in applications where a direct vessel connection used by the Type 484 is not possible, e. g. glass vessels.

¹⁾ Explanation of dead space ratio see page 18

Overview Page

General	5
Applications and References, General Design Features	6
HyTight Assembly	7
Surface Quality	8
Surface Definition	9
LESER Surface Packages	10
Clamp and threaded connections – Overview	12
Welded end and flange connections – Overview	14
Clamp connections – Overview	16
Low dead space	18

LESER Type Page

Type 481	19
Materials	
• Conventional design	20
How to order	
• Article numbers	22
• Available connections	23
Dimensions and weights	
• Metric Units	24
• US Units	25
Pressure temperature ratings	
• Metric Units + US Units	26
Selection chart H8	27
Surface quality	28
Approvals	29
Available options	30

Type 483 31

Materials	
• HyTight Assembly	32
How to order	
• Article numbers	34
• Available connections	35
Dimensions and weights	
• Metric Units	36
• US Units	37
Pressure temperature ratings	
• Metric Units + US Units	38
Selection chart H8	39
Surface quality	40
Approvals	41
Available options	42

LESER Type Page

Type 488	43
Materials	
• HyTight Assembly	44
How to order	
• Article numbers	46
• Available connections	47
Dimensions and weights	
• Metric Units	48/50
• US Units	49/51
Pressure temperature ratings	
• Metric Units + US Units	52
Selection chart H8	53
Surface quality	56
Approvals	57
Available options	58

Type 484 59

Materials	
• HyTight Assembly	60
How to order	
• Article numbers	62
• Available connections	63
Dimensions and weights	
• Metric Units	64
• US Units	65
Pressure temperature ratings	
• Metric Units + US Units	66
Selection chart H8	67
Surface quality	68
Approvals	69
Available options	70

Type 485 71

Materials	
• HyTight Assembly	72
How to order	
• Article numbers	74
• Available connections	75
Dimensions and weights	
• Metric Units	76
• US Units	77
Pressure temperature ratings	
• Metric Units + US Units	78
Selection chart H8	79
Surface quality	80
Approvals	81
Available options	82

LESER – Clean Service Safety Valves

The Clean Service product group represents:

- ✓ High aseptic properties
- ✓ Low dead space
- ✓ Best Cleanability (CIP, SIP or COP)

LESER's Clean Service Safety Valves

- are designed and manufactured to highest standards and fulfil hygienic and sanitary requirements acc. to
 - DIN 11866 (European Hygienic Pipes Standard)
 - ASME BPE (Bioprocessing Equipment)
 - EN 1672-2
 - DIN ISO 14159
 - USP class VI and FDA 21 CFR
 - serve for protection of processes and equipment in the foodstuff and pharmaceutical industry.
 - have a dead space ratio L/D < 0,33 (Type 484) up to < 3 (Type 488)
 - have a multiple choice of sanitary connections
 - are developed in a close cooperation with plant engineers and service specialists.
- are approved by all important approval organisations worldwide which ensures the worldwide applicability e. g.:
 - European Community: CE-marking acc. to Pressure Equipment Directive (PED) 97/23/EC and EN ISO 4126-1
 - USA: UV-stamp acc. to ASME Section VIII Division 1, National Board certified capacities
 - Germany: VdTÜV approval acc. to PED, EN ISO 4126-1, TÜV SV 100 and AD 2000-Merkblatt A2
 - Canada: Canadian Registration Number acc. to the requirements of particular provinces
 - China: AQSIQ based on the approval acc. to ASME Section VIII Division 1 and AD 2000-Merkblatt A2
 - Eurasian Custom Union: Approval acc. to Eurasian Custom Union (EAC - Eurasian Conformity)

Furthermore, all LESER Clean Service safety valves are designed, marked, produced and approved acc. to the requirements of the following regulations (directives, codes, rules and standards).

EN ISO 4126-7, EN 12266-1/-2, ASME PTC 25, ASME-Code Sec. II, ASME B 16.34, API Std. 527, API RP 576, AD 2000-Merkblatt A4, AD 2000-Merkblatt HP0



Applications and References

LESER's Clean Service Safety Valves

represent the ultimate solution for all critical clean service areas of

- Food industry
- Breweries and beverage
- Pharmaceutical industry
- Cosmetic industry
- Chemical industry
- Special processes

LESER's Clean Service Safety Valves are in use at well-known companies worldwide. Subsequently an extract of our references



General Design Features

LESER's Clean Service Safety Valves

offer a large variety of types, materials and options to suit any application:

Scope of design

- Valve sizes d_0 10 mm / 0,394 inch through d_0 92 mm / 3,622 inch
- Nine orifice sizes from 0,5 x D through P
- Materials: 1.4404 / 316L, 1.4435 / 316L stainless steel as a standard
- Standard soft seat for superior tightness
- Packed knob, packed lifting lever, gastight cap or pneumatic lifting device

No bacteria traps or contamination due to

- Minimum dead space design and flushmounting capability
- Wetted-part surfaces in compliance with European Hygienic Pipes Standard DIN 11866 and ASME BPE, part SD table SF-5 and SF-6
- Gap and crevice-free design of internals
- Standard elastomer bellows for protection of the hard to clean parts
- Self-draining body design, avoids residues and reduces corrosion
- Use of and compliant elastomer

Automatic plant operation during production and cleaning

- Optional pneumatic lifting device for cleaning in place (CIP) or sterilizing in place (SIP)
- Optional proximity switch to indicate the operating condition of the valve
- Self-draining body design and aseptic O-ring disc with bellows (HyTight Assembly) assure a cleanable outlet of the valve

Ease of plant design, installation and operation

- Variety of capacities and versions to fit any application
- Multiple choice of sanitary connections
- Single trim for steam, gas and liquid for less spare parts and easier maintenance
- Outlet chamber sealed from bonnet by EPDM bellows
- Crevice-free fastening of all elastomer parts
- Exposed, rinsed O-rings
- No bacteria traps or contamination

LESER's Clean Service Safety Valves

can be customized with a great variety of options, e. g.

- Special connections specified by the customer for optimised adaptation to the plant
- HyTight Assembly for superior tightness
- Every part can be replaced by other material acc. customer specification

Cleanability first

Cleanability first – this is the guideline for the design of the LESER Clean Service Safety Valves. Series 48X provides an optimum of cleanability. The following design features represent the ultimate solution for all critical clean service applications. HyTight stands for Hygienic and Tightness.

HyTight Assembly

The aseptic O-ring disc is the “heart” of the series 48X. This unique design provides for the first time a really cleanable in- and outlet of a safety valve:

- 1 The O-ring sealing provides superior tightness.
- 2 The elastomer bellows protects the hard-to-clean parts in the guiding and bonnet area against contamination. Please note: An elastomer bellows is not back pressure compensating like a stainless steel bellows.
- 3 All fixing elements like screws and nuts are placed inside of the bellows.
- 4 Crevice free internals, rinsed O-rings and FDA compliant elastomers insure there are no bacteria traps.

Availability

- Standard for Types 483, 484, 485, 488
- not available for Type 481

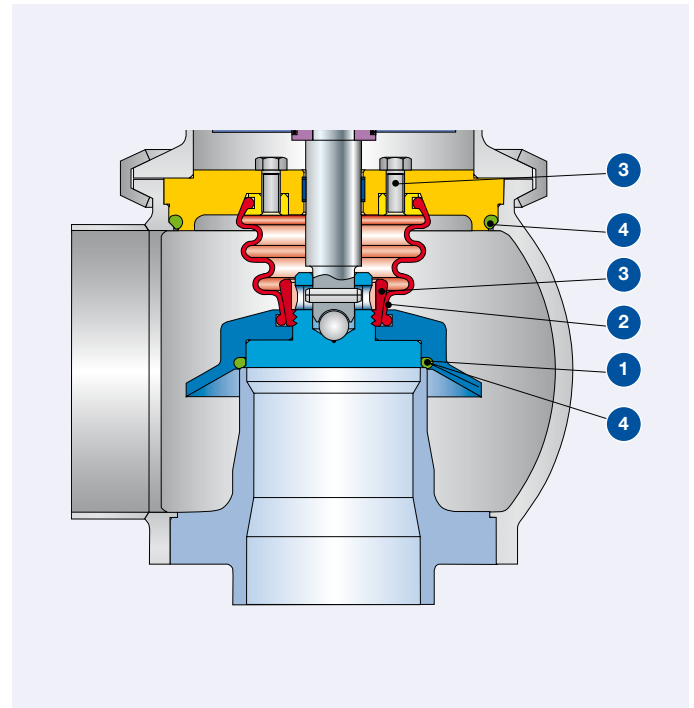

The European Hygienic Pipes Standard DIN 11866 as well as the ASME BPE provide guidances on the hygienic engineering aspects of manufacturing of safe and wholesome food.

The surface quality, especially area in contact with product, greatly influences the cleanability of the safety valve.

For instance the ASME BPE (Bioprocessing Equipment) states for cleanability:

SD-3.1.1:

- All surfaces shall be cleanable.
- Surface imperfections (e. g., crevices, gouges, obvious pits, etc.) shall be eliminated when ever feasible.

To ensure that the European as well as the ASME BPE requirements are fulfilled, no castings are used in the LESER Clean Service series. High surface quality is achieved by machining most valve bodies and all internal parts from high quality bar material.

Surface qualities		
Type	Standard surface qualities product contact inlet	Surface qualities of
481, 483, 488	$R_a < 0,750 \mu\text{m}$ $R_a < 30 \mu\text{inch}$ SFV3	$R_a < 0,500 \mu\text{m}$ $R_a < 20 \mu\text{inch}$
484, 485	$R_a < 0,750 \mu\text{m}$ electropolished $R_a < 30 \mu\text{inch}$ electropolished	for the product contact inlet are available on request, as well as electropolishing of the inside and outside of the valves

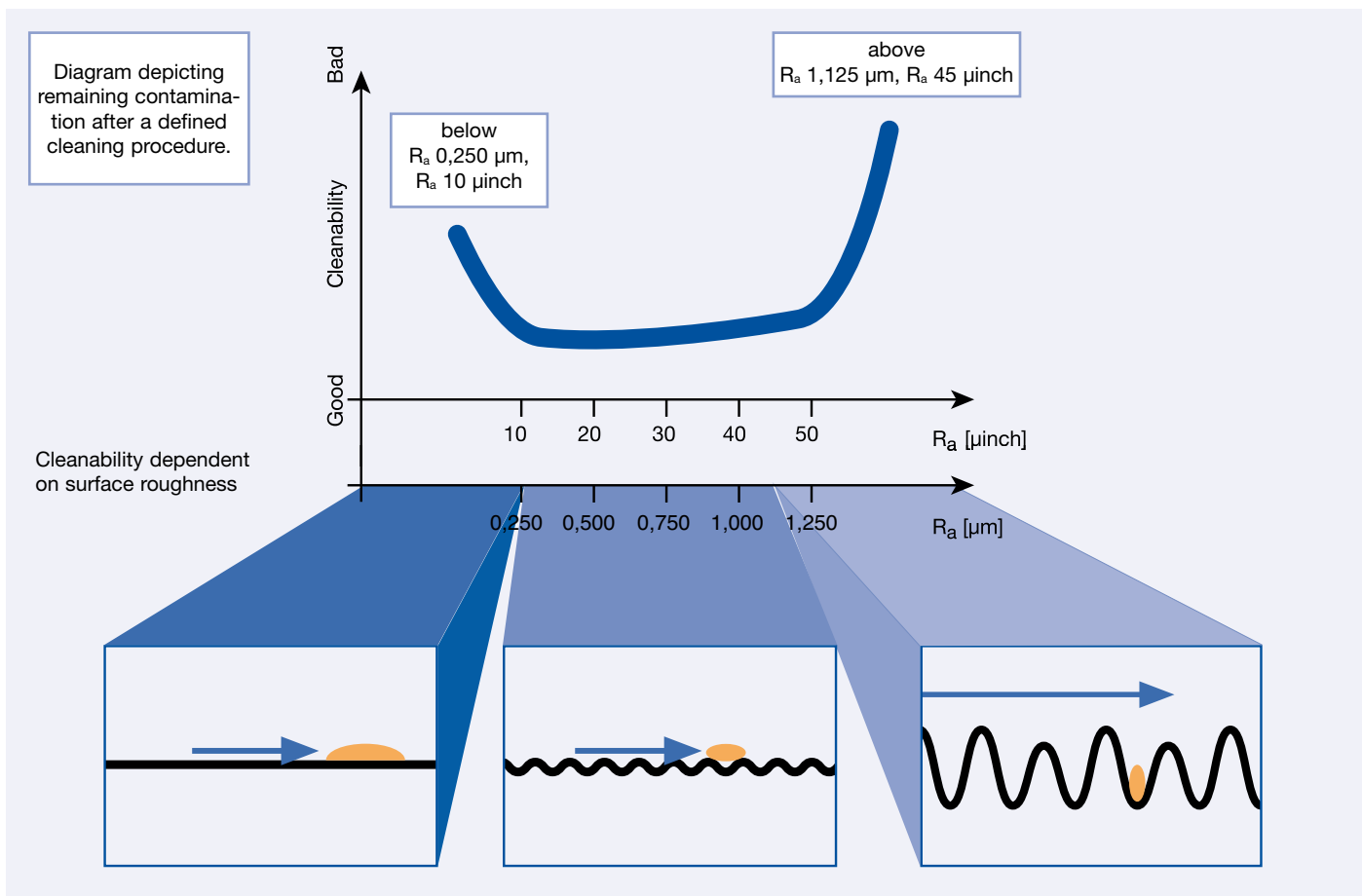

Below R_a 0,250 μm / 10 μinch bacteria or particles "stick" to the surface due to adhesive effects.

An optimized cleanability is reached with a surface roughness between R_a 0,250 μm / 10 μinch and R_a 1,125 μm / 45 μinch .

Above 1,125 μm / 45 μinch the bacteria and particles can "hide" in the corrugations or niches.

Clean Service Safety Valves

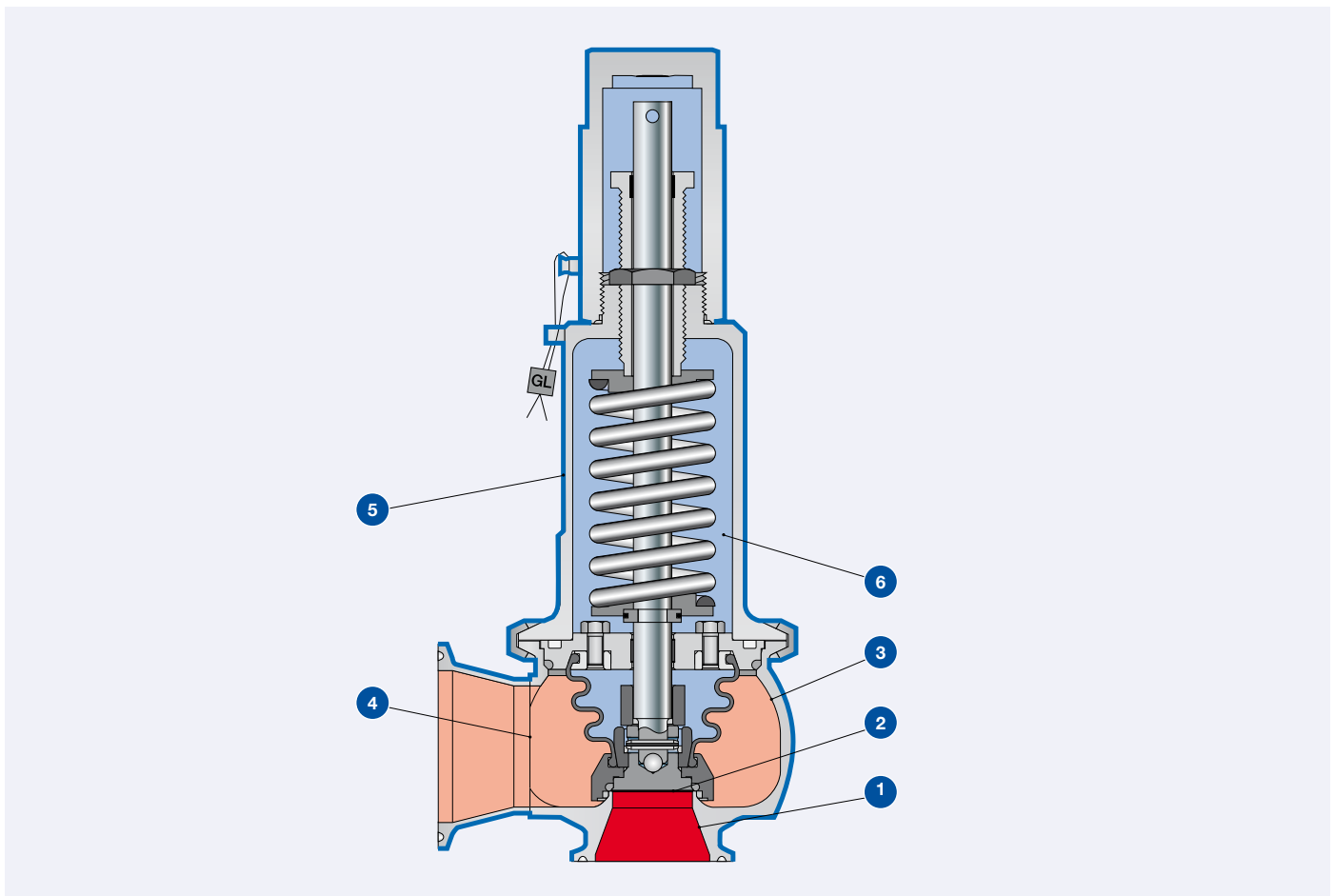

Surface definition

Area	Description	Surface definition acc. to ASME BPE
Product contact surface · No. 1 Inlet area · No. 2 Bottom side of disc	· Surface permanently in contact with the product	· Design acc. to Part SD · Surface finish in compliance table SF-5 · Different surface designation level acc. to table SF-6 is available
Blow off surface · No. 3 Inside surface of outlet area · No. 4 Welding seam	· Surface not permanently in contact with the product · During blow off surface is wetted with the product · This product cannot flow back to the process, if the outlet is not connected with the production process	· Surface finish preponderant in compliance table SF-5 · Weldings are not grinded · Surface designation level acc. to LESER specification
Outer surface · No. 5 Outside surface of body and bonnet	· This surface has no contact to the product, but a shiny surface is expected	· ASME BPE is not applicable · Design acc. to Part SD · Surface finish preponderant in compliance table SF-5 · Weldings are not grinded
Shielded surface · No. 6	· Surface never in contact with the product because it is shielded by the bellows	· ASME BPE is not applicable

In order to cover international surface requirements like DIN 11866 as well as ASME BPE, LESER defines surface packages (Clean finish, HyClean finish, Sterile finish) and surface grades (M1 – M6 mechanically polished, ME1 – ME6 mechanically polished and electropolished).

LESER surface grade

Depending on the manufacturing technology the LESER surface grade differentiates between mechanically polished and mechanically polished and electropolished. Following tables show the comparison of LESER surface grade, hygiene class according to DIN 11866 and surface designation according to ASME BPE.

LESER surface packages are:

- Clean finish LESER standard package mainly used in breweries
- HyClean finish Increased surface quality for e. g. dairys, cosmetics applications
- Sterile finish Increased surface quality for e. g. pharmaceutical applications

Option codes for available surface packages

Mechanically polished

LESER surface grade	Surface condition				DIN 11866	ASME BPE
	R _a max.		≅ R _z		Hygiene class	Surface designation
	[μm]	[μinch]	[μm]	[μinch]		
M1	0,375	15	2,5	64	H4	–
M2	0,500	20				SF1
M3	0,625	25				SF2
M4	0,750	30	4	102	H3	SF3
M5	1,500	60	10	254	H1	–
M6	3,000	120	16	406		–

Mechanically polished and electropolished

LESER surface grade	Surface condition				DIN 11866	ASME BPE
	R _a max.		≅ R _z		Hygiene class	Surface designation
	[μm]	[μinch]	[μm]	[μinch]		
ME1	0,375	15	2,5	64	HE4c	SF4
ME2	0,500	20				SF5
ME3	0,625	25				SF6
ME4	0,750	30	4	102	HE3c	–
ME5	1,500	60	10	254	HE1c	–
ME6	3,000	120	16	406		–

Overview option codes			
Type	LESER Surface packages		
	Clean finish	HyClean finish	Sterile finish
481	B50	B51	B52
483	B53	B54	B55
488	B68	B69	B70
484	B56	B57	B58
5034 Vessel connection	B59	B60	B61
485	B62	B63	B64
5034 Integrated pipework connection	B65	B66	B67

Clamp and threaded connections

Overview

LESER is able to deliver a wide range of connections required for clean service applications. For ordering the right connection please specify inlet and outlet by LESER option code. If the option code is not stated in this table please refer to connection pages of each Type.

Overview					
Connection	Clamp connection	Clamp connection	Clamp connection	Clamp connection	
Code	BO	SO	CO	DO	
According to	ASME BPE	DIN 32676	ISO 2852	ISO 2852	
Pipe standard	BS 4825-1	DIN 11850	ISO 2037	DIN EN ISO 1127	
Option code					
Type 481	d ₀ 10	Inlet ✓	✓	L96I79	✓
		Outlet I76A79	L86A16	L97A79	I74A16
Type 483	d ₀ 13	Inlet ✓	✓	✓	✓
		Outlet ✓	✓	✓	✓
	d ₀ 25	Inlet ✓	✓	✓	✓
		Outlet ✓	✓	✓	✓
Type 488	d ₀ 23	Inlet I75	L79	L96	I73
		Outlet I76	L86	L97	I74
	d ₀ 37	Inlet I75	L79	L96	I73
		Outlet I76	L86	L97	I74
	d ₀ 46	Inlet I75	L79	L96	I73
		Outlet I76	L86	L97	I74
	d ₀ 60	Inlet I75	L79	L96	I73
		Outlet ¹⁾	L86	L97	I74
	d ₀ 74	Inlet I75	L79	L96	I73
		Outlet ¹⁾	L86	L97	I74
	d ₀ 92	Inlet ¹⁾	L79	L96	I73
		Outlet ¹⁾	L86	L97	I74
Type 484	d ₀ 13	Inlet For inlet please select vessel connection Type 5034 as shown on page 62.			
		Outlet I76A80	L86A16	L97A80	I74A16
	d ₀ 25	Inlet For inlet please select vessel connection Type 5034 as shown on page 62.			
		Outlet I76A81	L86A17	L97A81	I74A17
Type 485	d ₀ 13	Inlet For inlet please select integrated pipework connection Type 5034 as shown on page 74.			
		Outlet I76A80	L86A16	L97A80	I74A16
	d ₀ 25	Inlet For inlet please select integrated pipework connection Type 5034 as shown on page 74.			
		Outlet I76A81	L86A17	L97A81	I74A17

¹⁾ Please select CO-Clamp

For better selection of the different clamp connecting dimensions please refer to page 16 and 17

Type	Other connections page
481	23
483	35
488	47
484	63
485	75

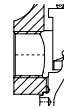
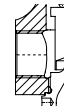

Threaded connection	Threaded connection
XG	XN
DIN ISO 228	ASME B 1.20.1
G 1/2 G 3/4 G 1	1/2" NPT 3/4" NPT 1" NPT

Option code	
-	-
✓	✓
-	-
-	-
-	-
-	-
-	-
-	-
-	-
-	-
-	-
-	-
-	-
-	-
-	-
-	-
-	-
-	-
-	-
-	-
-	-
-	-
-	-
-	-

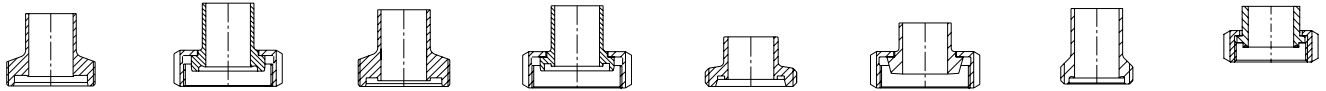

Aseptic thread	Aseptic clamp and nut	Aseptic thread	Aseptic clamp and nut	Aseptic thread	Aseptic clamp and nut	Sterile thread	Sterile clamp and nut
GS	BS	GT	BT	GO	KO	GD	BD
DIN 11864 T1 Range A	DIN 11864 T1 Range A	DIN 11864 T1 Range B	DIN 11864 T1 Range B	DIN 11851	DIN 11851	Neumo ²⁾	Neumo ²⁾
DIN 11850 DIN EN ISO 1127 BS 4825-1	DIN 11850 DIN EN ISO 1127 BS 4825-1	DIN 11850 DIN EN ISO 1127 BS 4825-1	DIN 11850 DIN EN ISO 1127 BS 4825-1	DIN 11850	DIN 11850	DIN 11850 DIN EN ISO 1127	DIN 11850 DIN EN ISO 1127
Option code							
✓	✓	✓	✓	H85L75I16	H85L76I16	✓	✓
✓	✓	✓	✓	A85L81A16	A85L82A16	✓	✓
✓	✓	✓	✓	H85L75I16	H85L76I16	✓	✓
✓	✓	✓	✓	A85L81A16	A85L82A16	✓	✓
✓	✓	✓	✓	H85L75I17	H85L76I17	✓	✓
✓	✓	✓	✓	A85L81A17	A85L82A17	✓	✓
✓	✓	✓	✓	✓	✓	✓	✓
✓	✓	✓	✓	✓	✓	✓	✓
✓	✓	✓	✓	✓	✓	✓	✓
✓	✓	✓	✓	✓	✓	✓	✓
✓	✓	✓	✓	✓	✓	✓	✓
✓	✓	✓	✓	✓	✓	✓	✓
✓ ¹⁾	✓ ¹⁾	✓ ¹⁾	✓ ¹⁾	✓	✓	✓	✓
✓	✓	✓	✓	✓	✓	✓	✓
-	-	-	-	✓	✓	-	-
✓ ¹⁾	✓ ¹⁾	✓ ¹⁾	✓ ¹⁾	✓	✓	✓	✓
-	-	-	-	✓	✓	-	-
-	-	-	-	-	-	-	-
✓	✓	✓	✓	A85L81A16	A85L82A16	✓	✓
-	-	-	-	-	-	-	-
✓	✓	✓	✓	A85L81A17	A85L82A17	✓	✓
-	-	-	-	-	-	-	-
✓	✓	✓	✓	A85L81A16	A85L82A16	✓	✓
-	-	-	-	-	-	-	-
✓	✓	✓	✓	A85L81A17	A85L82A17	✓	✓

¹⁾ Available for pipe standard DIN 11850 only

²⁾ BioConnect® is registered wordmark of NEUMO GmbH & Co. KG, D – 75438 Knittlingen

Welded end and flange connections

Overview

LESER is able to deliver a wide range of connections required for clean service applications. For ordering the right connection please specify inlet and outlet by LESER option code. If the option code is not stated in this table please refer to connection pages of each Type.

Type	Other connections page
481	23
483	35
488	47
484	63
485	75

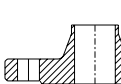
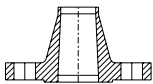
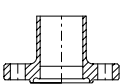
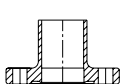
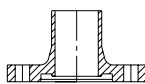
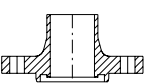
Overview									
Connection	Welded end	Flange PN 16 Range B1	Flange ASME Class 150RF	Aseptic flange groove	Aseptic flange tongue	Aseptic flange groove	Aseptic flange tongue		
Code	00	FD	FA	NF	BF	NG	BG		
According to	DIN 11850	DIN EN 1092	ASME B 16.5	DIN 11864 T2 Range A	DIN 11864 T2 Range A	DIN 11864 T2 Range B	DIN 11864 T2 Range B		
Pipe standard	DIN 11850	-	-	DIN 11850 DIN EN ISO 1127 BS 4825-1	DIN 11850 DIN EN ISO 1127 BS 4825-1	DIN 11850 DIN EN ISO 1127 BS 4825-1	DIN 11850 DIN EN ISO 1127 BS 4825-1		
Option code									
Type 481	d ₀ 10	Inlet	-	-	-	-	-	-	
		Outlet	-	-	-	-	-	-	
Type 483	d ₀ 13	Inlet	-	-	✓	✓	✓	✓	
		Outlet	A85L83A16	-	-	✓	✓	✓	✓
	d ₀ 25	Inlet	-	-	✓	✓	✓	✓	
		Outlet	A85L83A17	-	-	✓	✓	✓	✓
Type 488	d ₀ 23	Inlet	H85L77	I71	L94	✓	✓	✓	✓
		Outlet	A85L83	I72	L95	✓	✓	✓	✓
	d ₀ 37	Inlet	H85L77	I71	L94	✓	✓	✓	✓
		Outlet	A85L83	I72	L95	✓	✓	✓	✓
	d ₀ 46	Inlet	H85L77	I71	L94	✓	✓	✓	✓
		Outlet	A85L83	I72	L95	✓	✓	✓	✓
	d ₀ 60	Inlet	H85L77	I71	L94	✓	✓	✓	✓
		Outlet	A85L83	I72	L95	✓ ¹⁾	✓ ¹⁾	✓ ¹⁾	✓ ¹⁾
	d ₀ 74	Inlet	H85L77	I71	L94	✓	✓	✓	✓
		Outlet	A85L83	I72	L95	✓ ²⁾	✓ ²⁾	✓ ²⁾	✓ ²⁾
	d ₀ 92	Inlet	H85L77	I71	L94	✓ ¹⁾	✓ ¹⁾	✓ ¹⁾	✓ ¹⁾
		Outlet	-	I72	L95	✓ ²⁾	✓ ²⁾	✓ ²⁾	✓ ²⁾
Type 484	d ₀ 13	Inlet	-	-	-	-	-	-	
		Outlet	✓	-	-	✓	✓	✓	✓
	d ₀ 25	Inlet	-	-	-	-	-	-	
		Outlet	✓	-	-	✓	✓	✓	✓
Type 485	d ₀ 13	Inlet	-	-	-	-	-	-	
		Outlet	✓	-	-	✓	✓	✓	✓
	d ₀ 25	Inlet	-	-	-	-	-	-	
		Outlet	✓	-	-	✓	✓	✓	✓

¹⁾ Not available for pipe standard BS 4825-1

²⁾ Available for pipe standard DIN 11850 only

³⁾ XX = nominal pipe size of the safety valve.

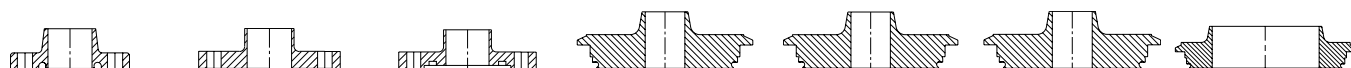

Varivent flange groove	APV-FG1 Flange flat face PN 10	APV-FG1 Flange groove PN 10	DN 32/XX ³⁾ Varivent connection	DN 50/XX ³⁾ Varivent connection	DN 80/XX ³⁾ Varivent connection	DN 100/XX ³⁾ Varivent connection
TN	AF	AN	VG	VH	VC	VE
Tuchenhagen	APV	APV	Tuchenhagen	Tuchenhagen	Tuchenhagen	Tuchenhagen
DIN 11850	DIN 11850	DIN 11850	-	-	-	-

Option code

-	-	-	-	-	-	-
-	-	-	-	-	-	-
H85H78I16	H85L90I16	H85L92I16	H85I82I16	H85I83I16	-	-
A85L84A16	A85L91A16	A85L93A16	-	-	-	-
H85H78I17	H85L90I17	H85L92I17	-	H85I83I17	-	-
A85L84A17	A85L91A17	A85L93A17	-	-	-	-
H85L78	L90	L92	I82	-	L70	L80
A85L84	L91	L93	-	-	-	-
H85L78	L90	L92	-	I83	L70	L80
A85L84	L91	L93	-	-	-	-
H85L78	L90	L92	-	-	L70	L80
A85L84	L91	L93	-	-	-	-
H85L78	L90	L92	-	-	L70	L80
A85L84	L91	L93	-	-	-	-
H85L78	L90	L92	-	-	L70	L80
A85L84	L91	L93	-	-	-	-
H85L78	L90	L92	-	-	-	L80
A85L84	L91	L93	-	-	-	-
-	-	-	-	-	-	-
A85L84A16	A85L91A16	A85L93A16	-	-	-	-
-	-	-	-	-	-	-
A85L84A17	A85L91A17	A85L93A17	-	-	-	-
-	-	-	-	-	-	-
A85L84A16	A85L91A16	A85L93A16	-	-	-	-
-	-	-	-	-	-	-
A85L84A17	A85L91A17	A85L93A17	-	-	-	-

Connecting dimensions

Most clamp connections can be delivered for different pipe standards, such as DIN 11850, ISO 2037, DIN EN ISO 1127 or special customer specifications.

The outer diameters generally the same so that there are no visual determinations between the clamps. Therefore the clamps are defined by inner and outer diameter (d_{inner} and d_{outer}). Additional indication of the pipe standard is not necessary.

For Type 481, 483 and 488 the clamps can be selected in different nominal diameters. Please state option code for clamp and for nominal diameter as shown on the connection pages of each Type.

SO – Clamp: DIN 32676			Pipe: DIN 11850 and DIN 11866 Range A							
Type		Inlet					Outlet			
Art.-No.	d_0 [mm]	DN	d_{inner} [mm]	d_{outer} [mm]	Option code	DN	d_{inner} [mm]	d_{outer} [mm]	Option code	
4814.	768/769	15	16,0	34,0	L79I14	–	–	–	–	
		25	26,0	50,5	L79I16	25	26,0	50,5	L86A16	
4834.	770	25	26,0	50,5	L79I16	25	26,0	50,5	L86A16	
	771	40	38,0	50,5	L79I17	40	38,0	50,5	L86A17	
4884.	884	25	26,0	50,5	L79	40	38,0	50,5	L86	
	885	40	38,0	50,5	L79	65	66,0	91,0	L86	
	886	50	50,0	64,0	L79	80	81,0	106,0	L86	
	887	65	66,0	91,0	L79	100	100,0	119,0	L86	
	888	80	81,0	106,0	L79	125	125,0	155,0	–	
	889	100	100,0	119,0	L79	150	150,0	183,0	–	
DO – Clamp: ISO 2852			Pipe: DIN EN ISO 1127 and DIN 11866 Range B							
Art.-No.	d_0 [mm]	DN	d_{inner} [mm]	d_{outer} [mm]	Option code	DN	d_{inner} [mm]	d_{outer} [mm]	Option code	
4814.	768/769	15	18,1	34,0	I73I14	–	–	–	–	
		25	29,7	50,5	I73I16	25	29,7	50,5	I74A16	
4834.	770	25	29,7	50,5	I73I16	25	29,7	50,5	I74A16	
	771	40	44,3	64,0	I73I17	40	44,3	64,0	I74A17	
4884.	884	25	29,7	50,5	I73	40	44,3	64,0	I74	
	885	40	44,3	64,0	I73	65	72,1	91,0	I74	
	886	50	56,3	77,5	I73	80	84,9	106,0	I74	
	887	65	72,1	91,0	I73	100	110,3	130,0	I74	
	888	80	84,9	106,0	I73	125	135,7	155,0	I74	
	889	100	110,3	130,0	I73	150	163,1	183,0	I74	

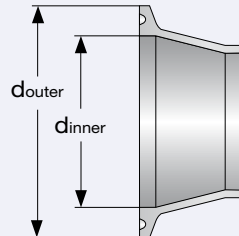

BO – Clamp: ASME BPE Pipe: BS 4825-1 and DIN 11866 Range C

Type		Inlet				Outlet				
Art.-No.	d ₀ [mm]	Size	d _{inner} [mm]	d _{outer} [mm]	Option code	Size	d _{inner} [mm]	d _{outer} [mm]	Option code	
4814.	768/769	10	3/4"	15,7	25,0	I75I78	–	–	–	–
			1" ¹⁾	22,1	50,5	I75I79	1" ¹⁾	22,1	50,5	I76A79
4834.	770	13	1" ¹⁾	22,1	50,5	I75I79	1 1/2"	34,8	50,5	I76A80
			1 1/2"	34,8	50,5	I75I80	1 1/2"	34,8	50,5	I76A80
	771	25	1 1/2"	34,8	50,5	I75I80	2"	47,5	64,0	I76A81
			2"	47,5	64,0	I75I81	2"	47,5	64,0	I76A81
4884.	884	23	1 1/2"	34,8	50,5	I75	2"	47,5	64,0	I76
	885	37	2"	47,5	64,0	I75	3"	72,9	91,0	I76
	886	46	2 1/2"	60,2	77,5	I75	4"	97,4	119,0	I76
	887	60	3"	72,9	91,0	I75	Please select CO-Clamp			
	888	74	4"	97,4	119,0	I75	Please select CO-Clamp			
	889	92	Please select CO-Clamp			Please select CO-Clamp				

CO – Clamp: ISO 2852 Pipe: ISO 2037

Art.-No.	d ₀ [mm]	Size ²⁾	d _{inner} [mm]	d _{outer} [mm]	Option code	Size ²⁾	d _{inner} [mm]	d _{outer} [mm]	Option code	
4814.	768/769	10	1"	22,6	50,5	L96I79	1"	22,6	50,5	L97A79
4834.	770	13	1"	22,6	50,5	L96I79	1 1/2"	35,6	50,5	L97A80
			1 1/2"	35,6	50,5	L96I80	1 1/2"	35,6	50,5	L97A80
	771	25	1 1/2"	35,6	50,5	L96I80	2"	48,6	64,0	L97A81
			2"	48,6	64,0	L96I81	2"	48,6	64,0	L97A81
4884.	884	23	1 1/2"	35,6	50,5	L96	2"	48,6	64,0	L97
	885	37	2"	48,6	64,0	L96	3"	72,9	91,0	L97
	886	46	2 1/2"	60,3	77,5	L96	4"	97,6	119,0	L97
	887	60	3"	72,9	91,0	L96	4 1/2"	110,3	130,0	L97
	888	74	4"	97,6	119,0	L96	5 1/2"	135,7	155,0	L97
	889	92	4 1/2"	110,3	130,0	L96	6,625"	163,1	183,0	L97

¹⁾ Type B

²⁾ No designation in ISO 2852 available. Please check compatibility of dimensions.

The dead space ratio is defined by ratio of the length of the inlet (L) to the diameter of the inlet pipe (D). The cleanability is improved as this ratio is reduced.

Types 481, 483 and 488 are improved solutions for safety valves with clamp connections, and have L/D ratios less than 1,5 and 2,0 (Type 488). The requirements of ASME BPE Part SD – 3.11.1 ($L/D < 2,0$) and FDA 21 CFR Part 177.2600 ($L/D < 1,5$) are fulfilled with these designs.

For some applications especially in the pharmaceutical industry the requirements are even higher. The solution for these particularly high purity requirements is Type 484 or Type 485 with special connections to the vessel or the piping, providing L/D ratios as low as 0,3 for Type 484 and $< 0,95$ for Type 485.

Dead space

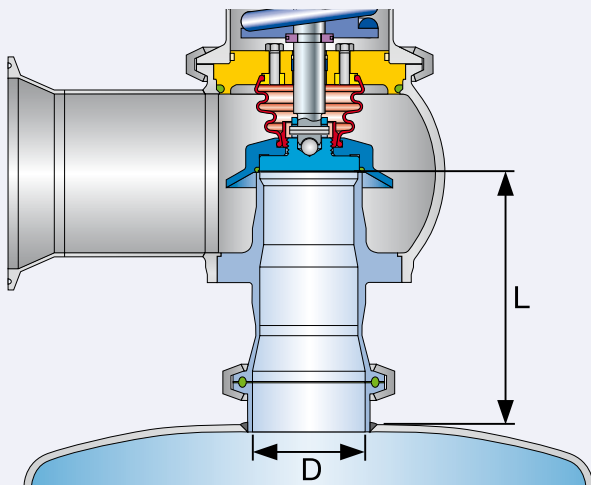

Type 488
 $L/D \sim 2,0$

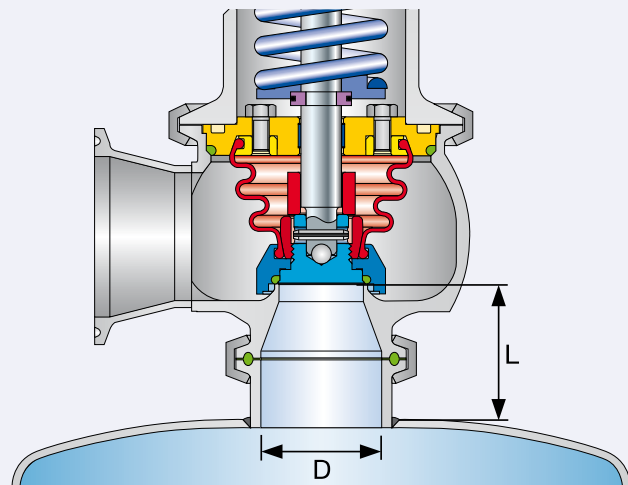

Type 483
 $L/D \sim 1,5$

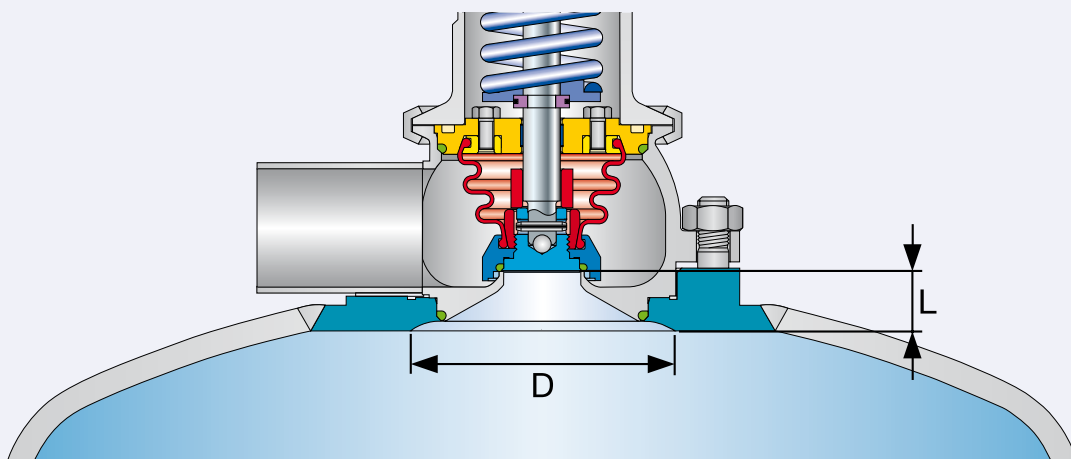

Type 484
 $L/D \sim 0,3$



Type 481
Cap H2
Inlet: Clamp connection
Outlet: Threaded connection

Type 481

Type 481

Safety Relief Valves – spring loaded



Type 481
Packed knob H4
Inlet: Aseptic clamp and nut
Outlet: Threaded connection

Contents	Page
Materials	
• Conventional design	20
How to order	
• Article numbers	22
• Available connections	23
Dimensions and weights	
• Metric Units	24
• US Units	25
Pressure temperature ratings	
• Metric Units + US Units	26
Selection chart H8	27
Surface quality	28
Approvals	29
Available options	30

Conventional design

Low set pressure

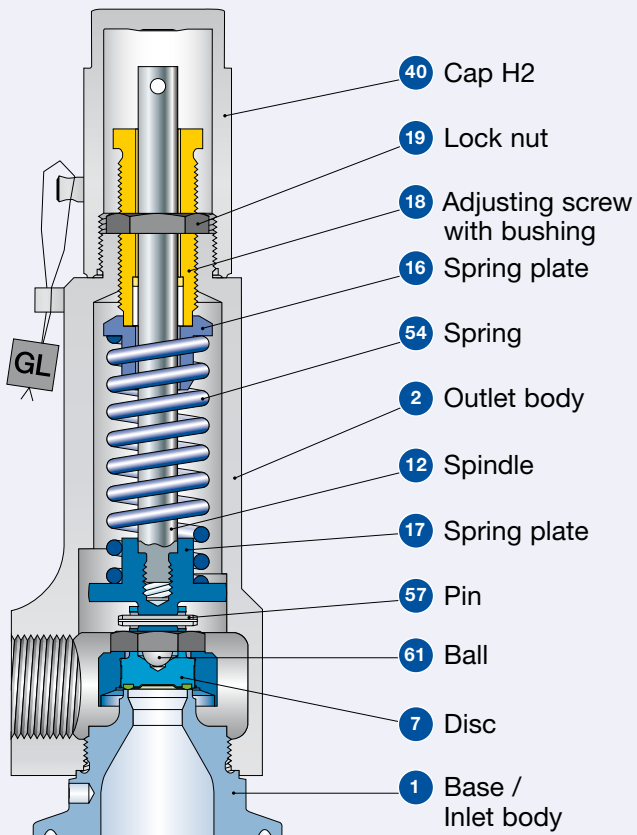

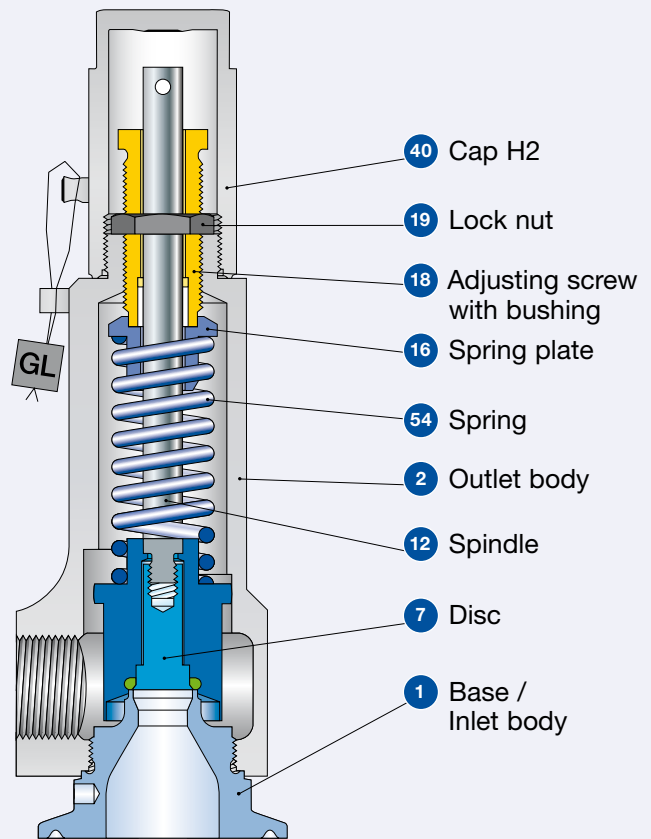

Type 481
with vulcanized soft seal
 Cap H2
 Set pressure: 0,1 – 16 bar
 1,5 – 232 psig
 Inlet: Clamp connection
 Outlet: Threaded connection

High set pressure



Type 481 with O-ring

Materials		Conventional design		
Item	Component	Remarks	Type 4814	
			Set pressure	
			0,1 – 16 bar 1,5 – 232 psig	16 – 68 bar 233 – 986 psig
			Vulcanized soft seal	O-ring disc
1	Base / Inlet body		1.4404	1.4404
			SA 479 316L	SA 479 316L
2	Outlet body		1.4404	1.4404
			SA 479 316L	SA 479 316L
7	Disc		1.4404	1.4404
			SA 479 316L	SA 479 316L
			Vulcanized soft seal	O-ring soft seal
7.1 or 7.4	Soft seal vulcanized or O-ring	“D” 	EPDM	EPDM
		“K”	CR	CR
		“L” 	FKM	FKM
		“N”	NBR	NBR
		“C” 	FFKM	FFKM
12	Spindle		1.4571	1.4571
			316Ti	316Ti
16	Spring plate		1.4404	1.4404
			316L	316L
17	Spring plate		1.4404	–
			316L	–
18	Adjusting screw with bushing	PTFE + 15 % glass	1.4404 / PTFE	1.4404 / PTFE
			316L / PTFE	316L / PTFE
19	Lock nut		1.4404	1.4404
			316L	316L
40	Cap H2		1.4404	1.4404
			316L	316L
54	Spring		1.4310	1.4310
			Stainless steel	Stainless steel
57	Pin		1.4310	–
			Stainless steel	–
61	Ball		1.4401	–
			316	–

Please notice:

- Modifications reserved by LESER.
- LESER can upgrade materials without notice.
- Every part can be replaced by other material acc. to customer specification.

Article numbers

Article numbers

	Vulcanized soft seal	O-ring disc
Actual Orifice diameter d_0 [mm]	10	10
Actual Orifice area A_0 [mm ²]	78,5	78,5
Actual Orifice diameter d_0 [inch]	0,394	0,394
Actual Orifice area A_0 [inch ²]	0,122	0,122
Soft seal material	EPDM "D" J22	EPDM "D" J22
	CR "K" J21	CR "K" J21
	FKM "L" J23	FKM "L" J23
	NBR "N" J30	NBR "N" J30
	FFKM "C" J20	FFKM "C" J20
Base / Inlet body material: 1.4404 (316L)		
Bonnet	H2 Art.-No. 4814.	7692
closed	H4 Art.-No. 4814.	7694
	H8 Art.-No. 4814.	7698
	p [bar] S/G/L	0,1 – 16
	p [psig] S/G/L	1,5 – 232
		7682
		7684
		7688
		16 – 68
		233 – 986

Available connections

Available connections			Available connections							
Actual Orifice diameter d_0 [mm]		10	d_0 [mm]		10					
Actual Orifice area A_0 [mm ²]		78,5	A_0 [mm ²]		78,5					
Clamps		Option code inlet		Clamps		Option code outlet				
	DN	15	25	DN	-	25				
	SO	L79I14	L79I16	SO	-	L86A16				
	DO	I73I14	I73I16	DO	-	I74A16				
	NPS	3/4"	1"	NPS	-	1"				
	BO	I75I78	I75I79	BO	-	I76A79				
	CO	-	L96I79	CO	-	L97A79				
Aseptic screwed connection		Option code inlet		Aseptic screwed connection		Option code outlet				
	DN	-		DN	G ^{1/2}	G ^{3/4}	G1	1/2" NPT	3/4" NPT	1" NPT
	XG	-		XG	V65	V76	V66	-		
	XN	-		XN	-		V70	V77	V71	
Pipe standard		DN		DN		25				
DIN 11850 / DIN 11866 Range A	GS	H85H34I16		GS	A85H35A16					
	BS	H85H36I16		BS	A85H37A16					
	GT	H85H54I16		GT	A85H55A16					
	BT	H85H56I16		BT	A85H57A16					
	GO	H85L75I16		GO	A85L81A16					
	KO	H85L76I16		KO	A85L82A16					
	GD	H85H60I16		GD	A85H61A16					
	BD	H85H58I16		BD	A85H59A16					
Pipe standard		DN		DN		25				
DIN EN ISO 1127 / DIN 11866 Range B	GS	H86H34I16		GS	A86H35A16					
	BS	H86H36I16		BS	A86H37A16					
	GT	H86H54I16		GT	A86H55A16					
	BT	H86H56I16		BT	A86H57A16					
	GD	H86H60I16		GD	A86H61A16					
	BD	H86H58I16		BD	A86H59A16					
Pipe standard		NPS		NPS		1"				
BS 4825-1 DIN 11866 Range C	GS	H66H34I79		GS	A84H35A79					
	BS	H66H36I79		BS	A84H37A79					
	GT	H66H54I79		GT	A84H55A79					
	BT	H66H56I79		BT	A84H57A79					

For definitions of connection codes please refer to pages 12 up to 15.

Dimensions and weights

Metric Units

Inlet clamp connections / Outlet clamp connections

	d_o [mm]			10	
	A_o [mm ²]			78,5	
Center to face	Inlet a [mm]			Outlet b [mm]	
	DN	15	25	DN	25
	SO	40	30	SO	65
	DO	40	30	DO	65
	NPS	3/4"	1"	NPS	1"
	BO	40	30	BO	65
	CO	-	30	CO	65
Clamp diameter d_{inner} [mm] and d_{outer} [mm]	For varying clamp diameters see page 16 and 17			For varying clamp diameters see page 16 and 17	
Height - H4 H max. [mm]	203	193			
Height - H8 H max. [mm] double piston design	231	221			
Weight max. [kg]	1,4	1,4			

Inlet clamp connections / Outlet threaded connections

	d_o [mm]			10		
	A_o [mm ²]			78,5		
Outlet threaded connections			XG	G ¹ / ₂	G ³ / ₄	G1
			XN	NPT ¹ / ₂ "	NPT ³ / ₄ "	NPT1"
			Center to face b [mm]	30	37	37
Inlet clamp diameters	SO	DN 15	Center to face a [mm]	40	40	43
		DN 25	Center to face a [mm]	30	30	33
	DO	DN 15	Center to face a [mm]	40	40	43
		DN 25	Center to face a [mm]	30	30	33
	BO	NPS 3/4"	Center to face a [mm]	40	40	43
		NPS 1"	Center to face a [mm]	30	30	33
	CO	NPS 1"	Center to face a [mm]	30	30	33
Clamp diameter d_{inner} [mm] and d_{outer} [mm]	For varying clamp diameters see page 16 and 17					
Height - H4 H max. [mm]				203	203	193
Height - H8 H max. [mm] double piston design				231	231	221
Weight max. [kg]				1,4	1,4	1,4

Inlet Aseptic screwed connections / Outlet Aseptic screwed connections

	d_o [mm]			10		
	A_o [mm ²]			78,5		
Center to face	Inlet a [mm]			Outlet b [mm]		
	GS	DN25, NPS 1"	45	GS	DN25, NPS 1"	72
	BS	DN25, NPS 1"	39	BS	DN25, NPS 1"	72
	GT	DN25, NPS 1"	43	GT	DN25, NPS 1"	72
	BT	DN25, NPS 1"	39	BT	DN25, NPS 1"	72
	GO	DN25	46	GO	DN25	72
	KO	DN25	39	KO	DN25	72
	GD	DN25	39	GD	DN25	72
	BD	DN25	42	BD	DN25	72
Height - H4 H max. [mm]			196			
Height - H8 H max. [mm] double piston design			224			
Weight max. [kg]			1,4			

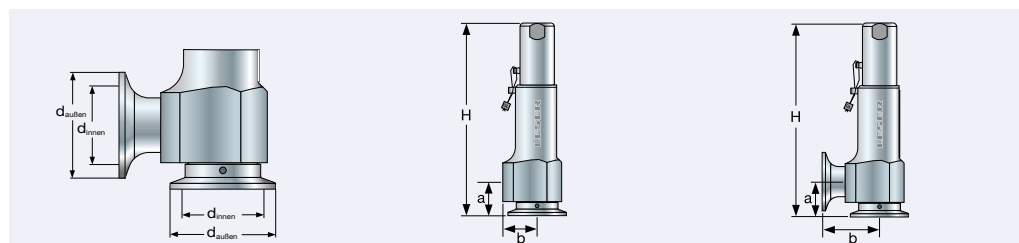

Type 481
Clamp diameters

Type 481
Outlet: Threaded connections

Type 481
Outlet: Clamp connection

Dimensions and weights

US Units

Inlet clamp connections / Outlet clamp connections						
		d_0 [inch]	10			
		A_0 [inch ²]	78,5			
Center to face		Inlet a [inch]		Outlet b [inch]		
	DN	15	25	DN	25	
	SO	1 ⁹ / ₁₆	1 ³ / ₁₆	SO	2 ⁹ / ₁₆	
	DO	1 ⁹ / ₁₆	1 ³ / ₁₆	DO	2 ⁹ / ₁₆	
	NPS	³ / ₄ "	1"	NPS	1"	
	BO	1 ⁹ / ₁₆	1 ³ / ₁₆	BO	2 ⁹ / ₁₆	
	CO	-	1 ³ / ₁₆	CO	2 ⁹ / ₁₆	
Clamp diameter d_{inner} [inch] and d_{outer} [inch]		For varying clamp diameters see page 16 and 17		For varying clamp diameters see page 16 and 17		
Height - H4 H max. [inch]		8	7 ¹⁹ / ₃₂			
Height - H8 H max. [inch] double piston design		9 ³ / ₃₂	8 ¹¹ / ₁₆			
Weight max. [lb]		3,086	3,086			
Inlet clamp connections / Outlet threaded connections						
		d_0 [inch]	0,394			
		A_0 [inch ²]	0,122			
Outlet threaded connections			XG	G ¹ / ₂	G ³ / ₄	G1
			XN	NPT ¹ / ₂ "	NPT ³ / ₄ "	NPT1"
			Center to face b [inch]	1 ³ / ₁₆	1 ⁷ / ₁₆	1 ⁷ / ₁₆
Inlet clamp diameters	SO	DN 15	Center to face a [inch]	1 ⁹ / ₁₆	1 ⁹ / ₁₆	1 ⁹ / ₁₆
		DN 25	Center to face a [inch]	1 ³ / ₁₆	1 ³ / ₁₆	1 ³ / ₁₆
	DO	DN 15	Center to face a [inch]	1 ⁹ / ₁₆	1 ⁹ / ₁₆	1 ⁹ / ₁₆
		DN 25	Center to face a [inch]	1 ³ / ₁₆	1 ³ / ₁₆	1 ³ / ₁₆
	BO	NPS ³ / ₄ "	Center to face a [inch]	1 ⁹ / ₁₆	1 ⁹ / ₁₆	1 ⁹ / ₁₆
		NPS 1"	Center to face a [inch]	1 ³ / ₁₆	1 ³ / ₁₆	1 ³ / ₁₆
	CO	NPS 1"	Center to face a [inch]	1 ³ / ₁₆	1 ³ / ₁₆	1 ³ / ₁₆
Clamp diameter d_{inner} [inch] and d_{outer} [inch]		For varying clamp diameters see page 16 and 17				
Height - H4 H max. [inch]		8	8	7 ⁵ / ₈		
Height - H8 H max. [inch] double piston design		9 ¹ / ₈	9 ¹ / ₈	8 ¹¹ / ₁₆		
Weight max. [lb]		3,086	3,086	3,086		
Inlet Aseptic screwed connections / Outlet Aseptic screwed connections						
		d_0 [inch]	10			
		A_0 [inch ²]	78,5			
Center to face		Inlet a [inch]		Outlet b [inch]		
	GS	DN25, NPS 1"	1 ³ / ₄	GS	DN25, NPS 1"	2 ¹³ / ₁₆
	BS	DN25, NPS 1"	1 ⁹ / ₁₆	BS	DN25, NPS 1"	2 ¹³ / ₁₆
	GT	DN25, NPS 1"	1 ¹¹ / ₁₆	GT	DN25, NPS 1"	2 ¹³ / ₁₆
	BT	DN25, NPS 1"	1 ⁹ / ₁₆	BT	DN25, NPS 1"	2 ¹³ / ₁₆
	GO	DN25	1 ¹³ / ₁₆	GO	DN25	2 ¹³ / ₁₆
	KO	DN25	1 ⁹ / ₁₆	KO	DN25	2 ¹³ / ₁₆
	GD	DN25	1 ⁹ / ₁₆	GD	DN25	2 ¹³ / ₁₆
	BD	DN25	1 ⁵ / ₈	BD	DN25	2 ¹³ / ₁₆
Height - H4 H max. [inch]		7 ¹¹ / ₁₆				
Height - H8 H max. [inch] double piston design		8 ¹³ / ₁₆				
Weight max. [lb]		3,086				

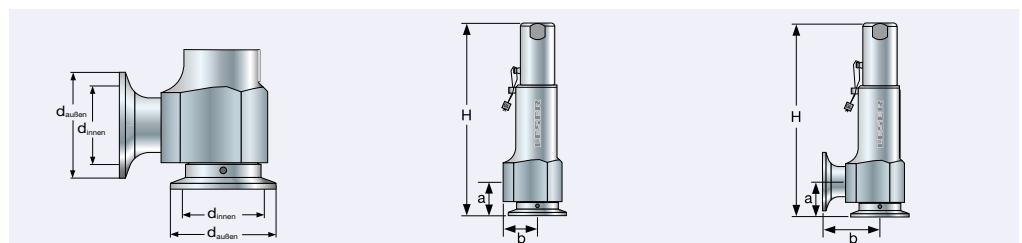

Type 481
Clamp diameters

Type 481
Outlet: Threaded connections

Type 481
Outlet: Clamp connection

Pressure temperature ratings

Metric Units

		Vulcanized soft seal		O-ring disc	
Actual Orifice diameter d_0 [mm]		10		10	
Actual Orifice area A_0 [mm ²]		78,5		78,5	
Body material: 1.4404 (316L)					
Inlet / Outlet body Pressure rating		For pressure ratings please refer to chapter dimensions and weights (page 24)			
Minimum set pressure	p [bar] S/G/L	0,1		16	
Maximum set pressure	p [bar] S/G/L	16		68	
Temperature range¹⁾		Minimum	Maximum	Minimum	Maximum
EPDM	[°C]	-45	+150	-45	+150
CR	[°C]	-40	+100	-40	+100
FKM	[°C]	-20	+180	-20	+180
NBR	[°C]	-25	+110	-25	+110
FFKM	[°C]	0	+250	0	+250

US Units

		Vulcanized soft seal		O-ring disc	
Actual Orifice diameter d_0 [inch]		0,394		0,394	
Actual Orifice area A_0 [inch ²]		0,122		0,122	
Body material: 1.4404 (316L)					
Inlet / Outlet body Pressure rating		For pressure ratings please refer to chapter dimensions and weights (page 25)			
Minimum set pressure	p [psig] S/G/L	1,5		233	
Maximum set pressure	p [psig] S/G/L	232		986	
Temperature range¹⁾		Minimum	Maximum	Minimum	Maximum
EPDM	[°F]	-49	+302	-49	+302
CR	[°F]	-40	+212	-40	+212
FKM	[°F]	-4	+356	-4	+356
NBR	[°F]	-13	+230	-13	+230
FFKM	[°F]	+32	+482	+32	+482

¹⁾ The temperature is limited by the soft seal material

Selection chart H8

Depending on the set pressure and lifting pressure (air supply) a double piston lifting device (option code J41) may be required instead of a single piston. The chart below determines the required lifting device.

Selection chart lifting device H8, size 0. d_0 10 mm / 0,394 inch

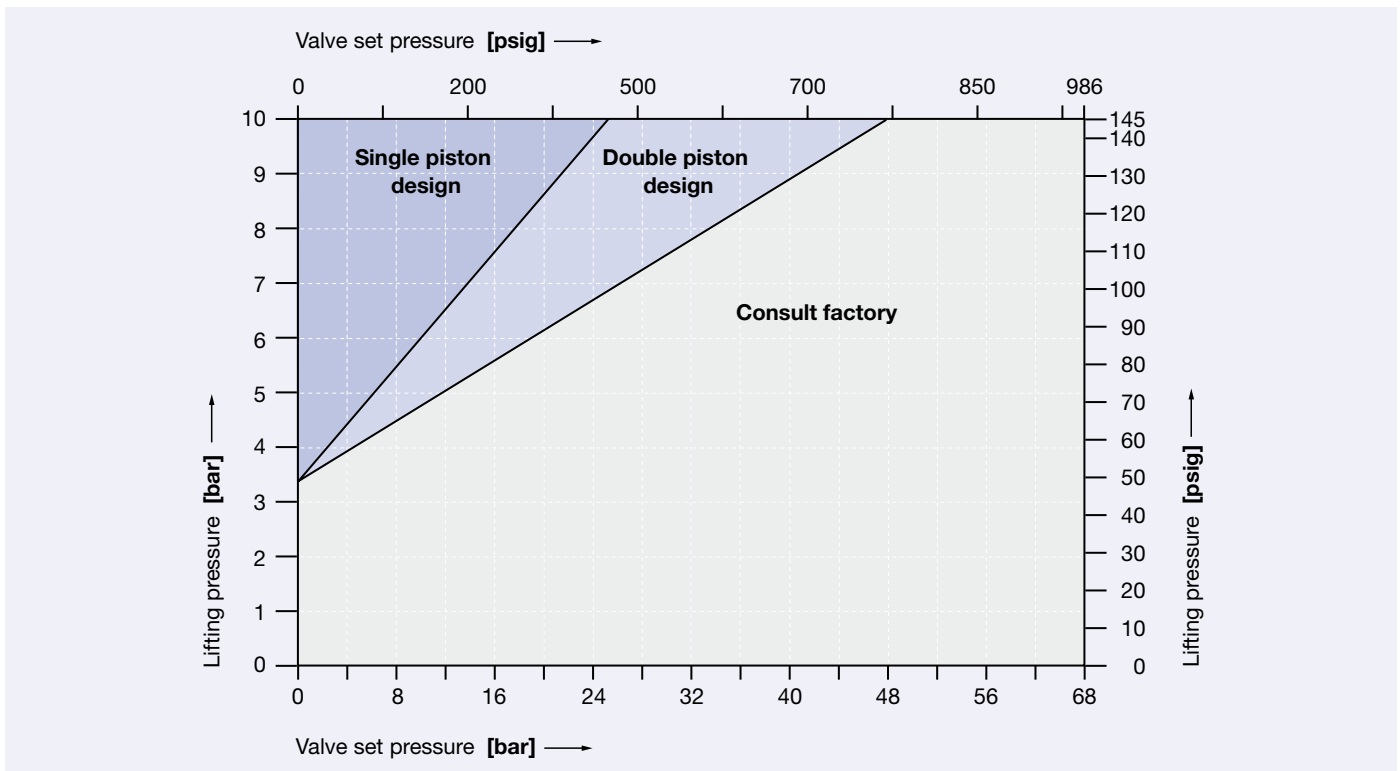

Surface quality

Type 481

Surface quality			LESER Surface package				
Type of surface	Area		Option code	Clean finish	HyClean finish	Sterile finish	
	Description	No.		B50	B51	B52	
				R _a max.	R _a max.	R _a max.	
LESER Surface grade							
Product contact surface	Inlet	1		M4	ME4	ME2	
			[µm]	0,750	0,750	0,500	
			[µinch]	30	30	20	
	Bottom side of disc						
	Soft seal design: Vulcanized	2		Elastomer surface			
				M4	ME4	ME2	
Soft seal design: O-ring	2	[µm]	0,750	0,750	0,500		
		[µinch]	30	30	20		
Blow off surface	Inside surface of outlet area	3		M6	ME6	ME6	
			[µm]	3,000	3,000	3,000	
			[µinch]	120	120	120	
Outer surface	Outside surface of inlet and outlet body, cap/lifting device	5		M6	ME6	ME6	
			[µm]	3,000	3,000	3,000	
			[µinch]	120	120	120	

If required surface deviates from standard specify No. and required LESER Surface Grade.

Type 481 – Vulcanized soft seal

Type 481 – O-ring disc

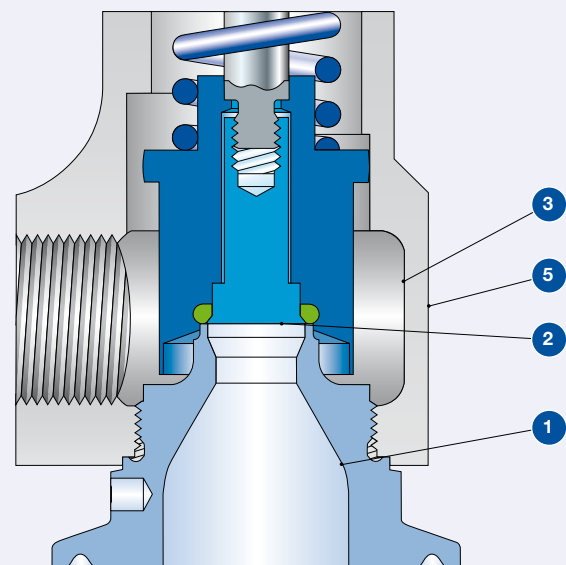
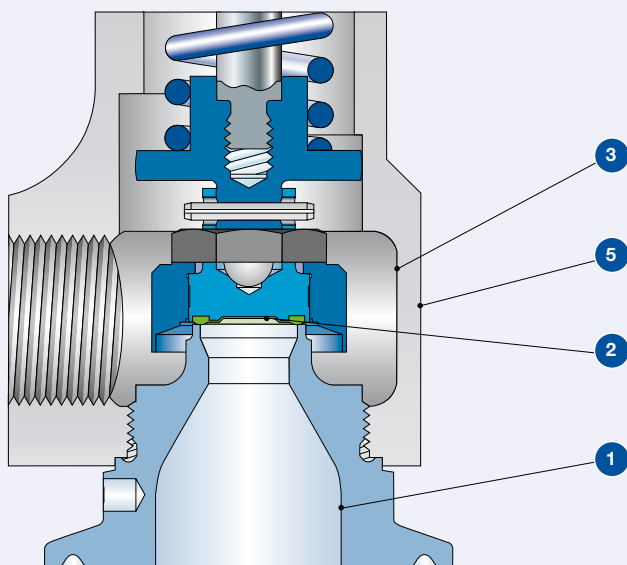

Approvals

Approvals			
Actual Orifice diameter d_0 [mm]		10	
Actual Orifice area A_0 [mm ²]		78,5	
Actual Orifice diameter d_0 [inch]		0,394	
Actual Orifice area A_0 [inch ²]		0,122	
Europe		Coefficient of discharge K_{dr}	
DIN EN ISO 4126-1	Approval No.	07 202 0111 Z 0008/0/21-2	
	S/G	0,45 (\leq 16 bar)	0,4 (> 16 bar)
	L	0,37 (\leq 16 bar)	0,33 (> 16 bar)
Germany		Coefficient of discharge α_w	
AD 2000-Merkblatt A2	Approval No.	TÜV SV 980	
	S/G	0,45 (\leq 16 bar)	0,4 (> 16 bar)
	L	0,37 (\leq 16 bar)	0,33 (> 16 bar)
United States		Coefficient of discharge K	
ASME Sec. VIII	Approval No.	M 37190	
	S/G	Rated slope acc. to ASME VIII, Div. 1 UG-131 (d) (2) S: 2,55 lb / hr / psia $\triangle K \approx 0,406$ G: 0,904 SCFM / psia 8 $\triangle K \approx 0,406$	
	Approval No.	M 37202	
	L	Rated slope acc. to ASME VIII, Div. 1 UG-131 (d) (2) L: 1,49 GPM $\sqrt{\text{psid}^*} \triangle K \approx 0,322$	
Canada		Coefficient of discharge K	
CRN	Approval No.	OG0772.9C	
	S/G	Rated slope acc. to ASME VIII, Div. 1 UG-131 (d) (2) S: 2,55 lb / hr / psia $\triangle K \approx 0,406$ G: 0,904 SCFM / psia $\triangle K \approx 0,406$	
	L	Rated slope acc. to ASME VIII, Div. 1 UG-131 (d) (2) L: 1,49 GPM $\sqrt{\text{psid}^*} \triangle K \approx 0,322$	
China		Coefficient of discharge α_w	
AQSIQ	Approval No.	02301T	
	S/G	0,45 (\leq 16 bar)	0,4 (> 16 bar)
	L	0,37 (\leq 16 bar)	0,33 (> 16 bar)
Eurasian Custom Union		Coefficient of discharge α_w	
EAC	Approval No.	For current approval no. see www.leser.com	
	S/G	0,45 (\leq 16 bar)	0,4 (> 16 bar)
	L	0,37 (\leq 16 bar)	0,33 (> 16 bar)
Classification societies		on request	

*) psid = Differential pressure $P - P_d$
P = absolute flow pressure [psia]
 P_d = pressure at discharge from valve [psia]

Available options

Type 481

Gastight cap H2
H2

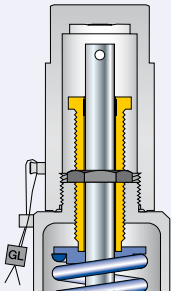

Gastight lifting device H4
Packed knob H4

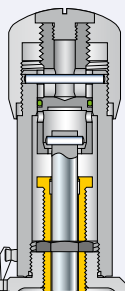

Pneumatic lifting device H8
H8 single piston design

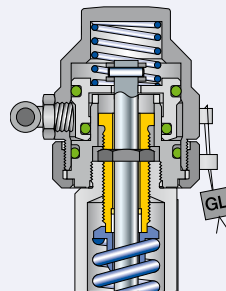

Pneumatic lifting device H8
J41: H8 double piston design

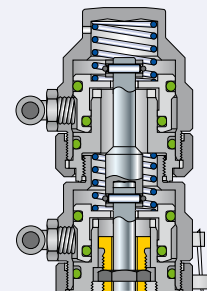

Vulcanized soft seal

- J22: EPDM "D"
- J21: CR "K"
- J23: FKM "L"
- J30: NBR "N"
- J20: FFKM "C"

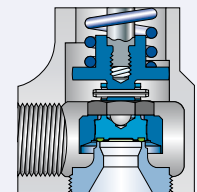

O-ring disc

- J22: EPDM "D"
- J21: CR "K"
- J23: FKM "L"
- J30: NBR "N"
- J20: FFKM "C"

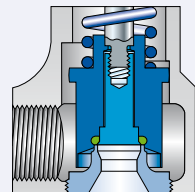

Test gag
J70: H2

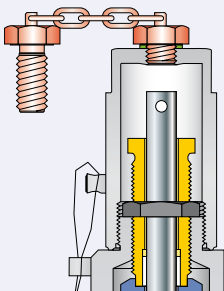

Female NPT outlet

- V70: 1/2"
- V77: 3/4"
- V71: 1"

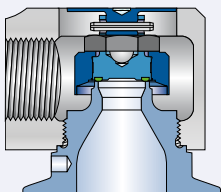

Clamp connection outlet

- I76A79: Clamp BO 1"
- L97A79: Clamp CO 1"

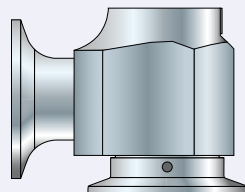

Special material

- 2.4610 HASTELLOY C4
- 2.4360 MONEL 400
- 1.4462 DUPLEX

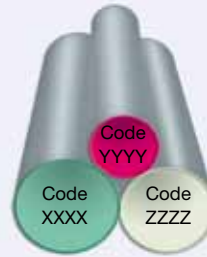

Type 483



Type 483
Pneumatic
lifting device H8
Inlet and outlet:
Clamp connection

Safety Relief Valves – spring loaded



Type 483
Packed knob H4
Inlet and outlet:
Flange connection

Contents

Page

Materials

- HyTight Assembly 32

How to order

- Article numbers 34
- Available connections 35

Dimensions and weights

- Metric Units 36
- US Units 37

Pressure temperature ratings

- Metric Units + US Units 38

Selection chart H8 39

Surface quality 40



Approvals 41

Available options 42

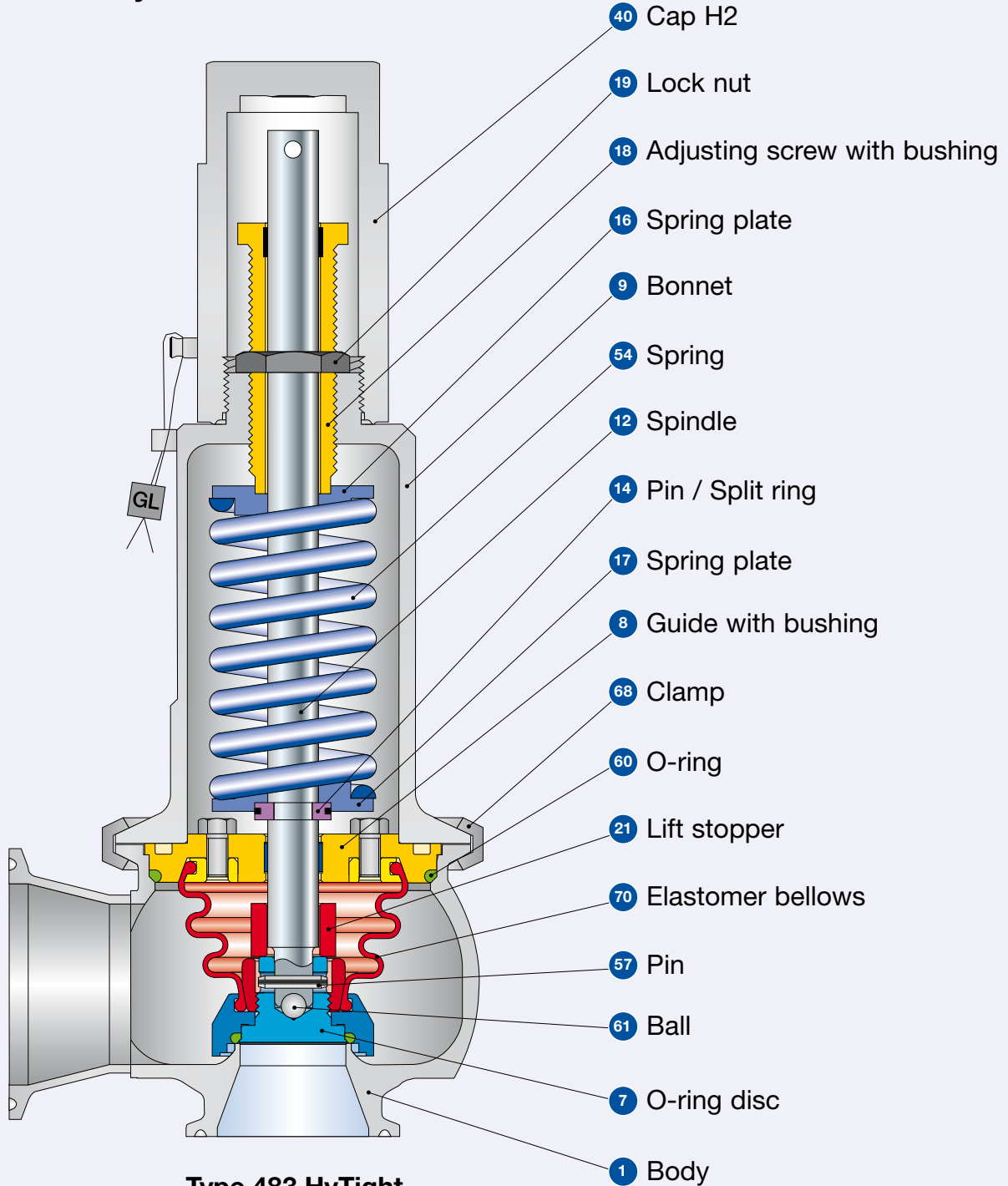
HyTight Assembly



Type 483 HyTight
 Cap H2
 Inlet and outlet:
 Clamp connection

Materials		HyTight Assembly	
Item	Component	Remarks	Type 4834 HyTight
1	Body		1.4435 (BN 2) ^{*)} SA 479 316L
7	O-ring disc	HyTight Assembly	1.4435 316L
7.4	Soft seal O-ring	"D" 	EPDM
		"C" 	FFKM
8	Guide with bushing	PTFE + 15 % glass	1.4435 316L
9	Bonnet		1.4404 316L
12	Spindle		1.4404 316L
14	Pin / Split ring		1.4310 / 1.4404 Stainless steel / 316L
16 / 17	Spring plate		1.4404 316L
18	Adjusting screw with bushing	PTFE + 15 % glass	1.4404 / PTFE 316L / PTFE
19	Lock nut		1.4404 316L
21	Lift stopper		1.4404 316L
40	Cap H2		1.4404 316L
54	Spring		1.4310 Stainless steel
57	Pin		1.4310 Stainless steel
60	O-ring		EPDM
61	Ball		1.4401 316
68	Clamp		1.4401 316
70	Elastomer bellows		EPDM

^{*)} The material 1.4435/SA 479 316L fulfils the requirements of the Swiss chemical and pharmaceutical industry Basler Norm (BN 2)

Please notice:

- Modifications reserved by LESER.
- LESER can upgrade materials without notice.
- Every part can be replaced by other material acc. to customer specification.

Article numbers

Article numbers				
Actual Orifice diameter d_0 [mm]		13	25	
Actual Orifice area A_0 [mm ²]		133	491	
Actual Orifice diameter d_0 [inch]		0,512	0,984	
Actual Orifice area A_0 [inch ²]		0,206	0,761	
O-ring material		EPDM "D" J22	EPDM "D" J22	
		FFKM "C" J20	FFKM "C" J20	
Body material: 1.4435 (316L)				
Bonnet closed	H2	Art.-No. 4834.	7702	7712
	H4	Art.-No. 4834.	7704	7714
	H8	Art.-No. 4834.	7708	7718
		p [bar] S/G/L	0,3 – 16	0,1 – 16
		p [psig] S/G/L	4,4 – 232	1,5 – 232

Available connections

Available connections							
Actual Orifice diameter d_0 [mm]		13		25			
Actual Orifice area A_0 [mm ²]		133		491			
Clamps		Option code inlet					
DN		25		40			
SO		L79I16		L79I17			
DO		I73I16		I73I17			
NPS		1"	1 1/2"	1 1/2"	2"		
BO		I75I79	I75I80	I75I80	I75I81		
CO		L96I79	L96I80	L96I80	L96I81		
Aseptic screwed connection		Option code inlet					
Pipe standard		DN		25		40	
DIN 11850 / DIN 11866 Range A		00		-			
		GS		H85H34I16		H85H34I17	
		BS		H85H36I16		H85H36I17	
		GT		H85H54I16		H85H54I17	
		BT		H85H56I16		H85H56I17	
		GO		H85L75I16		H85L75I17	
		KO		H85L76I16		H85L76I17	
		GD		H85H60I16		H85H60I17	
		BD		H85H58I16		H85H58I17	
Pipe standard		DN		25		40	
DIN EN ISO 1127 / DIN 11866 Range B		GS		H86H34I16		H86H34I17	
		BS		H86H36I16		H86H36I17	
		GT		H86H54I16		H86H54I17	
		BT		H86H56I16		H86H56I17	
		GD		H86H60I16		H86H60I17	
		BD		H86H58I16		H86H58I17	
Pipe standard		NPS		1"	1 1/2"	1 1/2"	2"
BS 4825-1 DIN 11866 Range C		GS		H66H34I79	H66H34I80	H66H34I80	H66H34I81
		BS		H66H36I79	H66H36I80	H66H36I80	H66H36I81
		GT		H66H54I79	H66H54I80	H66H54I80	H66H54I81
		BT		H66H56I79	H66H56I80	H66H56I80	H66H56I81
Aseptic flanged connection		Option code inlet					
Pipe standard		DN		25		40	
DIN 11850 / DIN 11866 Range A		NF		H85H71I16		H85H71I17	
		BF		H85H73I16		H85H73I17	
		NG		H85H75I16		H85H75I17	
		BG		H85H77I16		H85H77I17	
		TN		H85L78I16		H85L78I17	
		AF		H85L90I16		H85L90I17	
		AN		H85L92I16		H85L92I17	
		VG		H85I82I16		-	
		VH		H85I83I16		H85I83I17	
Pipe standard		DN		25		40	
DIN EN ISO 1127 / DIN 11866 Range B		NF		H86H71I16			
		BF		H86H73I16			
		NG		H86H75I16			
		BG		H86H77I16			
Pipe standard		NPS		1"	1 1/2"	1 1/2"	2"
BS 4825-1 DIN 11866 Range C		NF		H66H71I79	H66H71I80	H66H71I80	H66H71I81
		BF		H66H73I79	H66H73I80	H66H73I80	H66H73I81
		NG		H66H75I79	H66H75I80	H66H75I80	H66H75I81
		BG		H66H77I79	H66H77I80	H66H77I80	H66H77I81
Aseptic flanged connection		Option code outlet					
Pipe standard		DN		25		40	
		NF		A85H72A16		A85H72A17	
		BF		A85H74A16		A85H74A17	
		NG		A85H76A16		A85H76A17	
		BG		A85H78A16		A85H78A17	
		TN		A85L84A16		A85L84A17	
		AF		A85L91A16		A85L91A17	
		AN		A85L93A16		A85L93A17	
		VG		-		-	
		VH		-		-	
Pipe standard		DN		25		40	
		NF		A86H72A16		A86H72A17	
		BF		A86H74A16		A86H74A17	
		NG		A86H76A16		A86H76A17	
		BG		A86H78A16		A86H78A17	
Pipe standard		NPS		1 1/2"	2"		
		NF		A84H72A80		A84H72A81	
		BF		A84H74A80		A84H74A81	
		NG		A84H76A80		A84H76A81	
		BG		A84H78A80		A84H78A81	

For definitions of connection codes please refer to pages 12 up to 15.

Dimensions and weights

Metric Units

Actual Orifice diameter d_0 [mm]		13	25	13	25	
Actual Orifice area A_0 [mm ²]		133	491	133	491	
Welded connections			Inlet a		Outlet b	
	PN	16	16	16	16	
Center to face	[mm]	–	–	81,5	91,5	
Height – H4	H max. [mm]	–	–	–	–	
Height – H8 double piston design	H max. [mm]	–	–	–	–	
Clamp connections			Inlet a		Outlet b	
	PN	16	16	16	16	
Center to face	[mm]	29	44	52	60	
Clamp diameter	d_{inner} [mm] d_{outer} [mm]	For varying clamp diameters please refer to page 16 and 17		For varying clamp diameters please refer to page 16 and 17		
Height – H4	H max. [mm]	206	303	–	–	
Height – H8 double piston design	H max. [mm]	234	311	–	–	
Aseptic screwed connections			Inlet a		Outlet b	
	PN	16	16	16	16	
Center to face	[mm]	40	48	70	78	
Height – H4	H max. [mm]	217	304	–	–	
Height – H8 double piston design	H max. [mm]	245	312	–	–	
Aseptic flange connections			Inlet a		Outlet b	
	PN	16	16	16	16	
Center to face	[mm]	45 (AN: 40 mm)	51	76 (AN: 60 mm)	82	
Height – H4	H max. [mm]	222	310	–	–	
Height – H8 double piston design	H max. [mm]	250	318	–	–	
Weight						
Weight	max. [kg]	1,6	3,7			

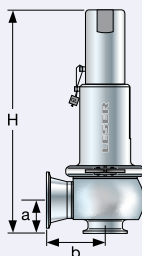

Type 483 – Cap H2

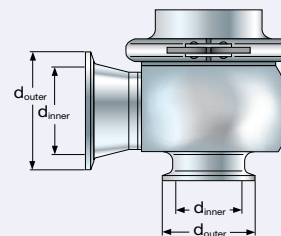

Type 483 – Clamp diameters

Dimensions and weights

US Units				
Actual Orifice diameter d_o [inch]		0,512	0,984	
Actual Orifice area A_o [inch ²]		0,206	0,761	
Welded connections		Inlet a		
	PN	16	16	
Center to face	[inch]	–	–	
Height – H4	H max. [inch]	–	–	
Height – H8 double piston design	H max. [inch]	–	–	
Clamp connections		Inlet a		
	PN	16	16	
Center to face	[inch]	1 ⁵ / ₃₂	1 ²³ / ₃₂	
Clamp diameter	d_{inner} [inch]	For varying clamp diameters please refer to page 16 and 17		
	d_{outer} [inch]			
Height – H4	H max. [inch]	1 ⁵ / ₃₂	1 ²³ / ₃₂	
Height – H8 double piston design	H max. [inch]	8 ¹ / ₈	11 ¹⁵ / ₁₆	
Aseptic screwed connections		Inlet a		
	PN	16	16	
Center to face	[inch]	1 ⁹ / ₁₆	1 ⁷ / ₈	
Height – H4	H max. [inch]	8 ¹⁷ / ₃₂	11 ³¹ / ₃₂	
Height – H8 double piston design	H max. [inch]	9 ²⁷ / ₃₂	12 ¹⁷ / ₃₂	
Aseptic flange connections		Inlet a		
	PN	16	16	
Center to face	[inch]	1 ²⁵ / ₃₂ (AN: 1 ⁵ / ₈)	2	
Height – H4	H max. [inch]	8 ³ / ₄	12 ⁷ / ₃₂	
Height – H8 double piston design	H max. [inch]	9 ²⁷ / ₃₂	12 ¹⁷ / ₃₂	
Weight				
Weight	max. [lb]	3,527	8,157	

		Outlet b	
		0,512	0,984
		0,206	0,761
		Outlet b	
		16	16
		3 ⁷ / ₃₂	3 ¹⁹ / ₃₂
		–	–
		–	–
		Outlet b	
		16	16
		2 ¹ / ₁₆	2 ³ / ₈
		For varying clamp diameters please refer to page 16 and 17	
		–	–
		–	–
		Outlet b	
		16	16
		2 ³ / ₄	3 ¹ / ₁₆
		–	–
		–	–
		Outlet b	
		16	16
		3 (AN: 2 ³ / ₈)	3 ⁷ / ₃₂
		–	–
		–	–

Type 483

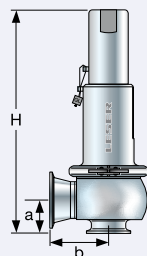

Type 483 – Cap H2

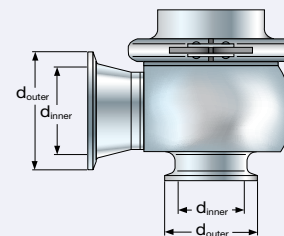

Type 483 – Clamp diameters

Pressure temperature ratings

Metric Units

Actual Orifice diameter d_0 [mm]		13		25	
Actual Orifice area A_0 [mm ²]		133		491	
Body material: 1.4435 (316L)					
Inlet	Pressure rating	For pressure ratings and connection size please refer to chapter dimensions and weights (page 36)			
Outlet	Pressure rating				
Minimum set pressure	p [bar] S/G/L	0,3		0,1	
Maximum set pressure	p [bar] S/G/L	16		16	
Temperature range¹⁾		Minimum	Maximum	Minimum	Maximum
EPDM	[°C]	-45	+150	-45	+150
FFKM	[°C]	0	+250	0	+250

US Units

Actual Orifice diameter d_0 [inch]		0,512		0,984	
Actual Orifice area A_0 [inch ²]		0,206		0,761	
Body material: 1.4435 (316L)					
Inlet	Pressure rating	For pressure ratings and connection size please refer to chapter dimensions and weights (page 37)			
Outlet	Pressure rating				
Minimum set pressure	p [psig] S/G/L	4,4		1,5	
Maximum set pressure	p [psig] S/G/L	232		232	
Temperature range¹⁾		Minimum	Maximum	Minimum	Maximum
EPDM	[°F]	-49	+302	-49	+302
FFKM	[°F]	+32	+482	+32	+482

¹⁾ The temperature is limited by the soft seal material.

Selection chart H8

Depending on the set pressure and lifting pressure (air supply) a double piston lifting device (option code J41) may be required instead of a single piston. The chart below determines the required lifting device.

Selection chart lifting device H8, size 0. d_0 13 mm / 0,512 inch

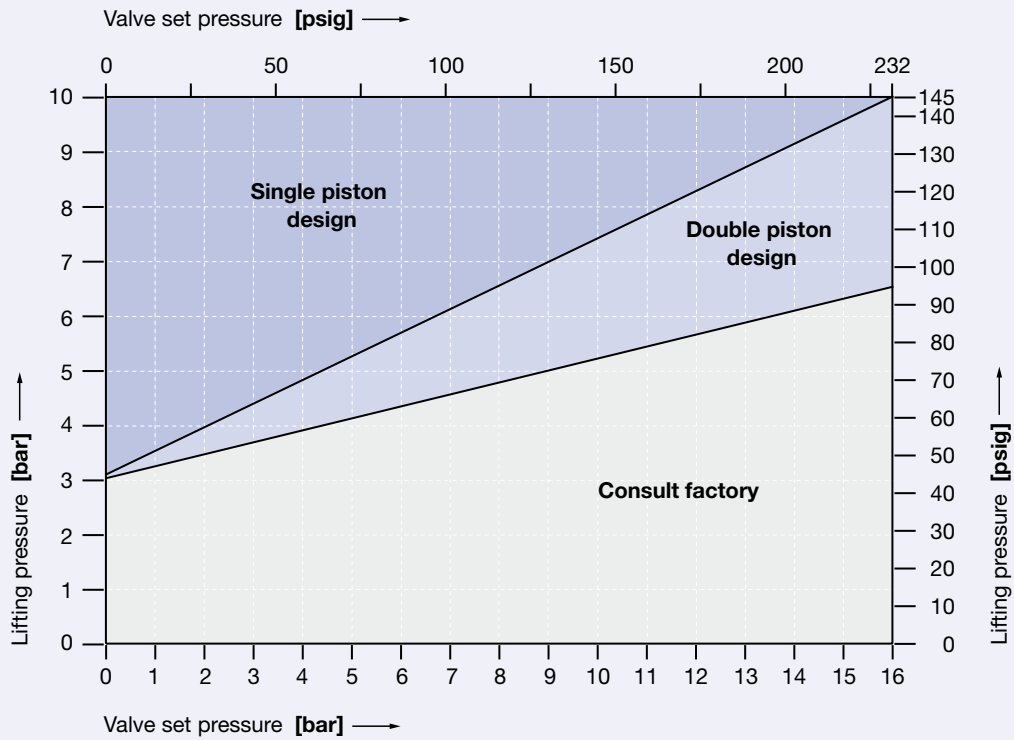

Selection chart lifting device H8, size I. d_0 25 mm / 0,984 inch

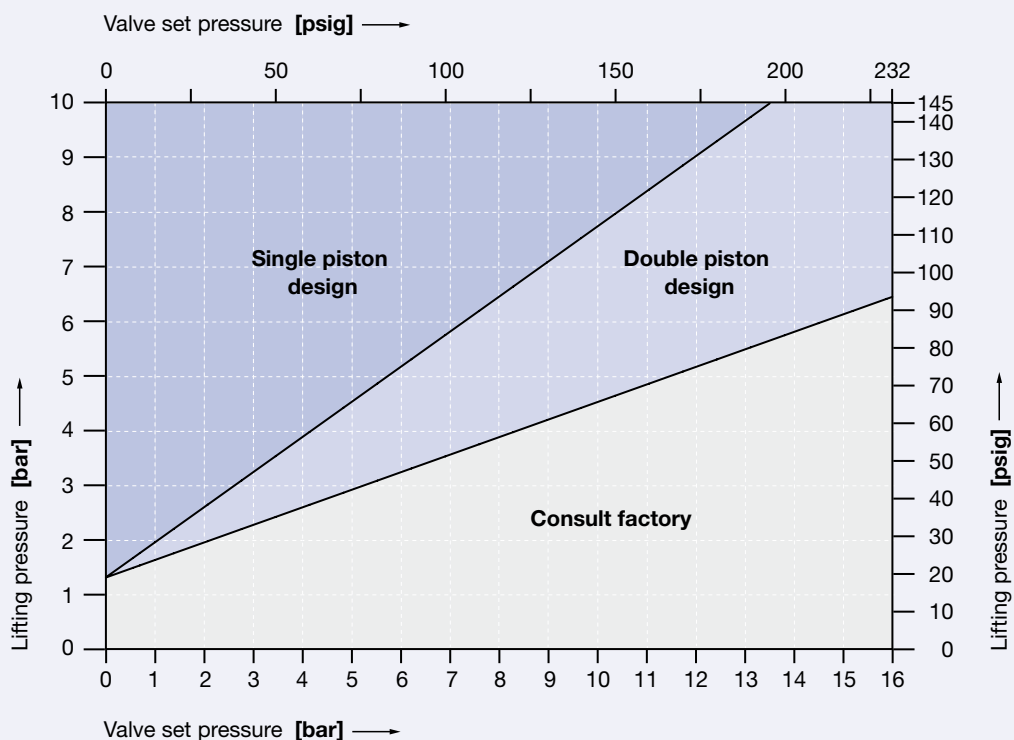

Type 483

Surface quality

Surface quality			LESER Surface package			
Type of surface	Area		Option code	Clean finish	HyClean finish	Sterile finish
	Description	No.		B53	B54	B55
				R _a max.	R _a max.	R _a max.
LESER Surface grade						
Product contact surface	Inlet	1	[μm]	M4 0,750	ME4 0,750	ME1 0,375
			[μinch]	30	30	15
	Bottom side of disc	2	[μm]	M4 0,750	ME4 0,750	ME1 0,375
			[μinch]	30	30	15
Blow off surface	Inside surface of outlet area	3	[μm]	M5 1,500	ME5 1,500	ME4 0,750
			[μinch]	60	60	30
	Welding seam	4	[μm]	M6 3,000	ME6 3,000	ME6 3,000
			[μinch]	120	120	120
Outer surface	Outside surface of body, bonnet and cap/lifting device	5	[μm]	M5 1,500	ME5 1,500	ME4 0,750
			[μinch]	60	60	30
Shielded surface	Surface never in contact with the product because it is shielded by the bellows	6		No definition		

If required surface deviates from standard specify No. and required LESER Surface Grade.

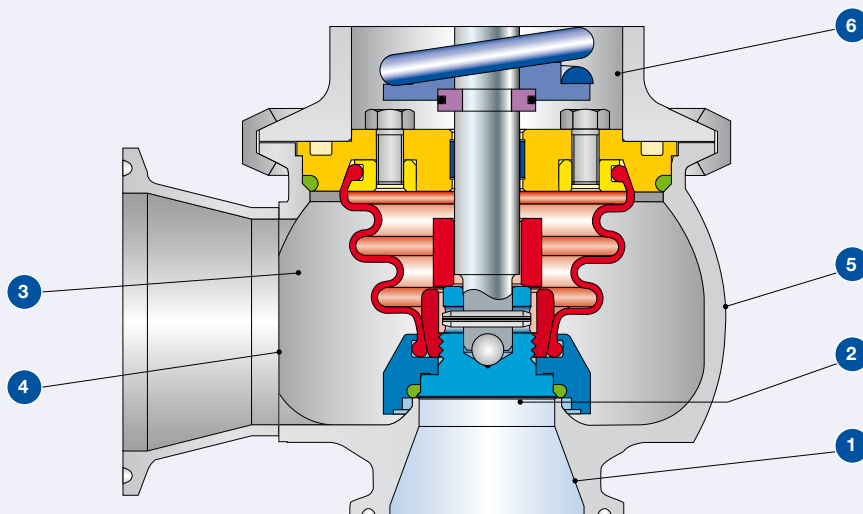

Approvals

Approvals			
Actual Orifice diameter d_0 [mm]		13	25
Actual Orifice area A_0 [mm ²]		133	491
Actual Orifice diameter d_0 [inch]		0,512	0,984
Actual Orifice area A_0 [inch ²]		0,206	0,761
Europe		Coefficient of discharge K_{dr}	
DIN EN ISO 4126-1	Approval No.	07 202 0111 Z 0008/0/20	
	S/G	0,6	0,38
	L	0,4	0,26
Germany		Coefficient of discharge α_w	
AD 2000-Merkblatt A2	Approval No.	TÜV SV 1047	
	S/G	0,6	0,38
	L	0,4	0,26
United States		Coefficient of discharge K	
ASME Sec. VIII	Approval No.	M37145	M37167
	S/G	Rated slope acc. to ASME VIII, Div. 1 UG-131 (d) (2) S: 5,52 lb / hr / psia $\triangle K \approx 0,521$ G: 1,96 SCFM / psia $\triangle K \approx 0,521$	Rated slope acc. to ASME VIII, Div. 1 UG-131 (d) (2) S: 13,97 lb / hr / psia $\triangle K \approx 0,357$ G: 4,96 SCFM / psia $\triangle K \approx 0,357$
	Approval No.	M37156	M37178
	L	Rated slope acc. to ASME VIII, Div. 1 UG-131 (d) (2) L: 2,96 GPM $\sqrt{\text{psid}^*} \triangle K \approx 0,379$	Rated slope acc. to ASME VIII, Div. 1 UG-131 (d) (2) L: 7,46 GPM $\sqrt{\text{psid}^*} \triangle K \approx 0,258$
Canada		Coefficient of discharge K	
CRN	Approval No.	OG0772.9C	
	S/G	Rated slope acc. to ASME VIII, Div. 1 UG-131 (d) (2) S: 5,52 lb / hr / psia $\triangle K \approx 0,521$ G: 1,96 SCFM / psia $\triangle K \approx 0,521$	Rated slope acc. to ASME VIII, Div. 1 UG-131 (d) (2) S: 13,97 lb / hr / psia $\triangle K \approx 0,357$ G: 4,96 SCFM / psia $\triangle K \approx 0,357$
	L	Rated slope acc. to ASME VIII, Div. 1 UG-131 (d) (2) L: 2,96 GPM $\sqrt{\text{psid}^*} \triangle K \approx 0,379$	Rated slope acc. to ASME VIII, Div. 1 UG-131 (d) (2) L: 7,46 GPM $\sqrt{\text{psid}^*} \triangle K \approx 0,258$
China		Coefficient of discharge α_w	
AQSIQ	Approval No.	02301T	
	S/G	0,6	0,38
	L	0,4	0,26
Eurasian Custom Union		Coefficient of discharge α_w	
EAC	Approval No.	For current approval no. see www.leser.com	
	S/G	0,6	0,38
	L	0,4	0,26
Classification societies			
on request			

*) psid = Differential pressure P-P_d
P = absolute flow pressure [psia]
P_d = pressure at discharge from valve [psia]

Available options

Type 483

Gastight cap H2
H2

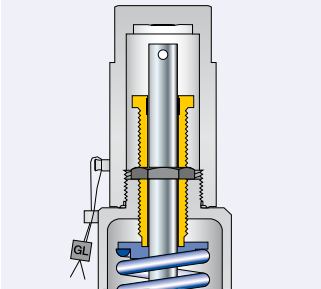

Gastight lifting device H4
Packed knob H4

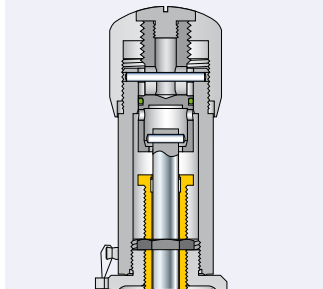



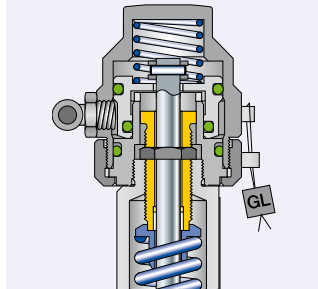

Pneumatic lifting device H8
H8 single piston design

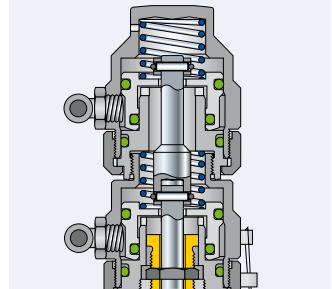



Pneumatic lifting device H8
J41: H8 double piston design

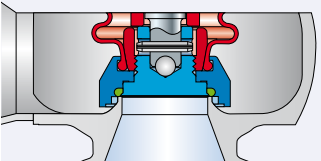

O-ring-disc

J22: EPDM "D"  
J20: FFKM "C"  



Bellows FFKM "C" 

S70 - only for d₀13

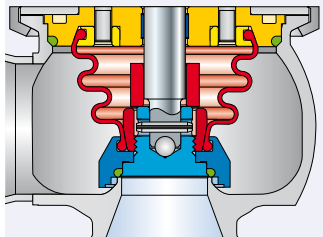

Test gag
J70: H2

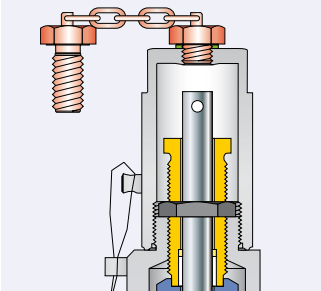

Lift indicator placed in bonnet
J38 + J93

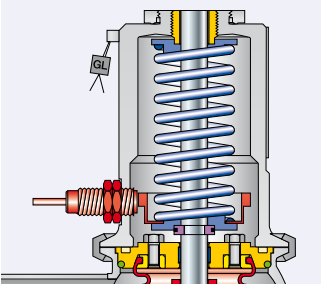

Multiple possibilities of aseptic connections

- Dairy industry coupling
- Sterile screw coupling
- Small flange
- Clamp

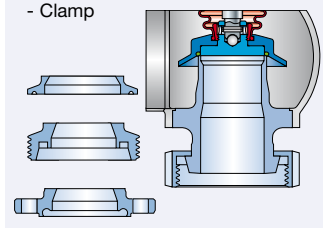

Special material

- 2.4610 HASTELLOY C4
- 2.4360 MONEL 400
- 1.4462 DUPLEX

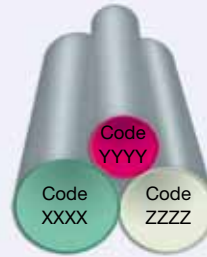

Type 488

Safety Relief Valves – spring loaded



Type 488
Cap H2
Inlet and outlet:
Clamp connection



Type 488
Packed knob H4
Inlet and outlet:
Flange connection

Contents

Page

Materials

- HyTight Assembly 44

How to order

- Article numbers 46
- Available connections 47

Dimensions and weights

- Metric Units 48/50
- US Units 49/51

Pressure temperature ratings

- Metric Units + US Units 52

Selection chart H8 53

Surface quality 56





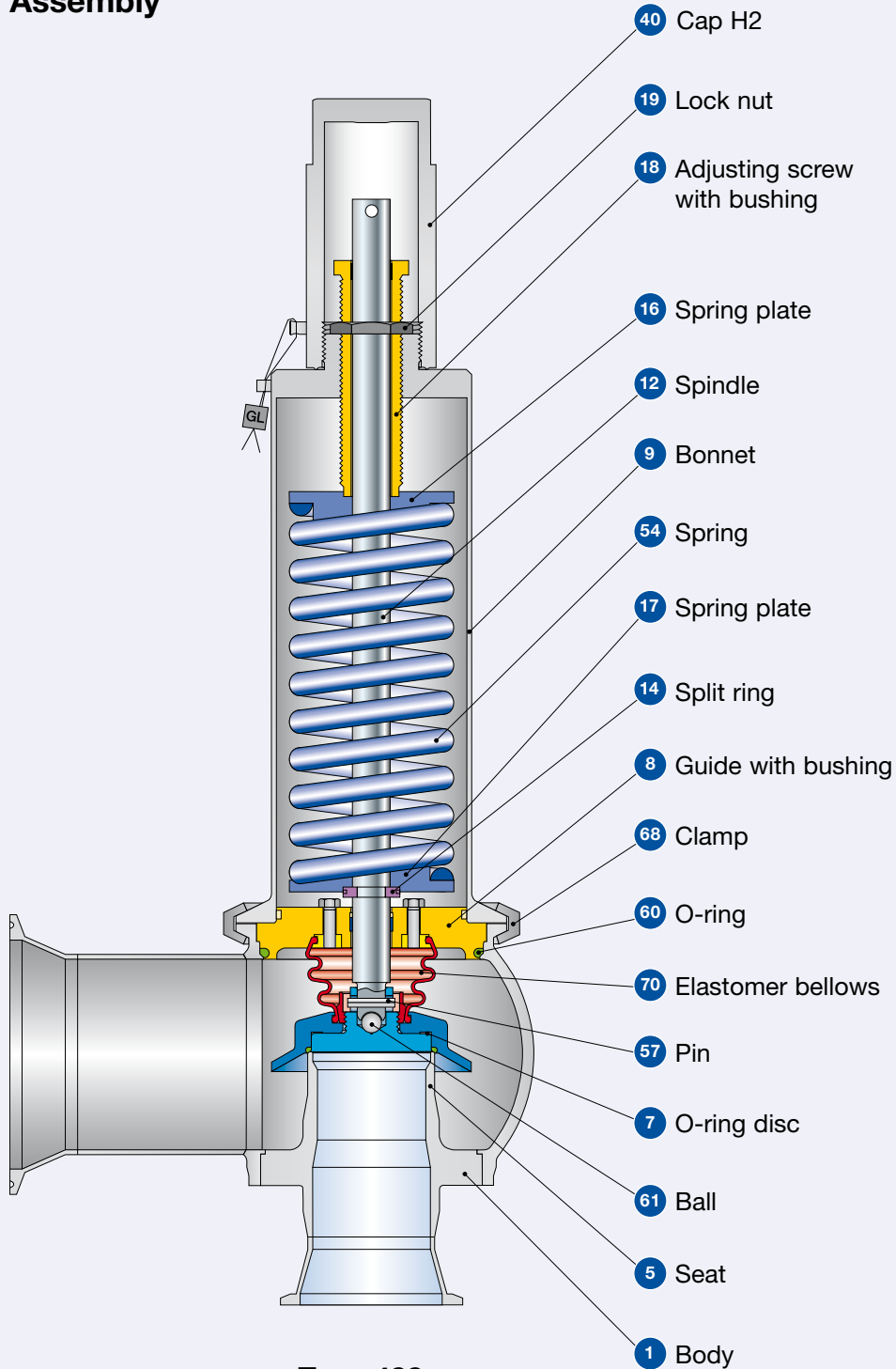

Approvals 57

Available options 58

HyTight Assembly



Type 488
 Cap H2
 Inlet and outlet: Clamp connection

Materials		HyTight Assembly	
Item	Component	Remarks	Type 4884 HyTight
1	Body		1.4404
			SA 479 316L
5	Seat		1.4404
			316L
7	O-ring disc	HyTight Assembly	1.4404
			316L
7.4	Soft seal O-ring	"D"  	EPDM
		"K"	CR
		"L" 	FKM
		"C"  	FFKM
8	Guide with bushing	PTFE + 15 % glass	1.4404
			316L
9	Bonnet		1.4404
			SA 479 316L
12	Spindle		1.4404
			316L
14	Split ring		1.4404
			316L
16 / 17	Spring plate		1.4404
			316L
18	Adjusting screw with bushing	PTFE + 15 % glass	1.4104 / PTFE
			430 / PTFE
19	Lock nut		1.4404
			316L
40	Cap H2		1.4404
			316L
54	Spring		1.4310
			Stainless steel
57	Pin		1.4310
			Stainless steel
60	O-ring		EPDM
61	Ball		1.4401
			316
68	Clamp		1.4401
			316
70	Elastomer bellows		EPDM

Please notice:

- Modifications reserved by LESER.
- LESER can upgrade materials without notice.
- Every part can be replaced by other material acc. to customer specification.

Article numbers

Article numbers								
Actual Orifice diameter d_0 [mm]		23	37	46	60	74	92	
Actual Orifice area A_0 [mm ²]		416	1075	1662	2827	4301	6648	
Actual Orifice diameter d_0 [inch]		0,906	1,457	1,811	2,362	2,913	3,622	
Actual Orifice area A_0 [inch ²]		0,644	1,667	2,576	4,383	6,666	10,304	
O-ring material		EPDM "D" J22	EPDM "D" J22	EPDM "D" J22	EPDM "D" J22	EPDM "D" J22	EPDM "D" J22	EPDM "D" J22
		CR "K" J21	CR "K" J21	CR "K" J21	CR "K" J21	CR "K" J21	CR "K" J21	CR "K" J21
		FKM "L" J23	FKM "L" J23	FKM "L" J23	FKM "L" J23	FKM "L" J23	FKM "L" J23	FKM "L" J23
		FFKM "C" J20	FFKM "C" J20	FFKM "C" J20	FFKM "C" J20	FFKM "C" J20	FFKM "C" J20	FFKM "C" J20
Body material: 1.4404 (316L)		HyTight						
Bonnet closed	H2	Art.-No. 4884.	8842	8852	8862	8872	8882	8892
	H4	Art.-No. 4884.	8844	8854	8864	8874	8884	8894
	H8	Art.-No. 4884.	8848	8858	8868	8878	8888	8898
		p [bar] S/G/L	0,1 – 16	0,1 – 16	0,2 – 15	0,1 – 10,34	0,1 – 10,34	0,1 – 8,2
		p [psig] S/G/L	1,5 – 232	1,5 – 232	3 – 217,56	1,5 – 150	1,5 – 150	1,5 – 118,9

Available connections

	d ₀ [mm]	23	37	46	60	74	92		d ₀ [mm]	23	37	46	60	74	92	
	A ₀ [mm ²]	416	1057	1662	2827	4301	6648		A ₀ [mm ²]	416	1057	1662	2827	4301	6648	
Clamps Option code inlet								Clamps Option code outlet								
	DN	25	40	50	65	80	100		DN	40	65	80	100	125	150	
	SO	L79							SO	L86						-
	DO	I73							DO	I74						
	NPS	1 1/2"	2"	2 1/2"	3"	4"	1)		NPS	2"	3"	4"	1)	1)	1)	
	BO	I75							BO	I76						
	NPS	1 1/2"	2"	2 1/2"	3"	4"	4 1/2"		NPS	2"	3"	3 1/2"	4 1/2"	5 1/2"	6,625"	
	CO	L96							CO	L97						
Aseptic screwed connection Option code inlet								Aseptic screwed connection Option code outlet								
Pipe standard	DN	25	40	50	65	80	100		DN	40	65	80	100	125	150	
DIN 11850 / DIN 11866 Range A	00	H85L77							00	A85L83						-
	GS	H85H34							GS	A85H35						-
	BS	H85H36							BS	A85H37						-
	GT	H85H54							GT	A85H55						-
	BT	H85H56							BT	A85H57						-
	GO	H85L75							GO	A85L81						-
	KO	H85L76							KO	A85L82						-
	GD	H85H60							GD	A85H61						-
	BD	H85H58							BD	A85H59						-
Pipe standard	DN	25	40	50	65	80	100		DN	40	65	80	100	125	150	
DIN EN ISO 1127 / DIN 11866 Range B	GS	H86H34						-	GS	A86H35						-
	BS	H86H36						-	BS	A86H37						-
	GT	H86H54						-	GT	A86H55						-
	BT	H86H56						-	BT	A86H57						-
	GD	H86H60						-	GD	A86H61						-
	BD	H86H58						-	BD	A86H59						-
Pipe standard	NPS	1 1/2"	2"	2 1/2"	3"	4"	4 1/2"		NPS	2"	3"	4"	4 1/2"	5"	6"	
BS 4825-1 DIN 11866 Range C	GS	H66H34						-	GS	A84H35						-
	BS	H66H36						-	BS	A84H37						-
	GT	H66H54						-	GT	A84H55						-
	BT	H66H56						-	BT	A84H57						-
Flanged connection Option code inlet								Flanged connection Option code outlet								
	DN	25	40	50	65	80	100		DN	40	65	80	100	125	150	
	FD	I71							FD	I72						
	NPS	1"	1 1/2"	2"	2 1/2"	3"	4"		NPS	1 1/2"	2 1/2"	3"	4"	5"	6"	
	FA	L94							FA	L95						
Aseptic flanged connection Option code inlet								Aseptic flanged connection Option code outlet								
Pipe standard	DN	25	40	50	65	80	100		DN	40	65	80	100	125	150	
DIN 11850 / DIN 11866 Range A	NF	H85H71							NF	A85H72						
	BF	H85H73							BF	A85H74						
	NG	H85H75							NG	A85H76						
	BG	H85H77							BG	A85H78						
	TN	H85L78							TN	A85L84						
	AF	L90							AF	L91						
	AN	L92							AN	L93						
	VC	L70						-	VC							-
	VG	182						-	VG							-
	VH	183						-	VH							-
VE	L80							VE							-	
Pipe standard	DN	25	40	50	65	80	100		DN	40	65	80	100	125	150	
DIN EN ISO 1127 / DIN 11866 Range B	NF	H86H71							NF	A86H72						-
	BF	H86H73							BF	A86H74						-
	NG	H86H75							NG	A86H76						-
	BG	H86H77							BG	A86H78						-
Pipe standard	NPS	1 1/2"	2"	2 1/2"	3"	4"	4 1/2"		NPS	2"	3"	4"	4 1/2"	5"	6"	
BS 4825-1 DIN 11866 Range C	NF	H66H71							NF	A84H72						-
	BF	H66H73							BF	A84H74						-
	NG	H66H75							NG	A84H76						-
	BG	H66H77							BG	A84H78						-

For definitions of connection codes please refer to pages 12 up to 15.

¹⁾ Please select CO-Clamp

Dimensions and weights

Metric Units

Actual Orifice diameter d_0 [mm]		23	37	46	60	74	92	23	37	46	60	74	92
Actual Orifice area A_0 [mm ²]		416	1075	1662	2827	4301	6648	416	1075	1662	2827	4301	6648
Welded connections		Inlet a						Outlet b					
	PN	16	16	16	16	16	16	16	16	16	16	16	16
Center to face	[mm]	53	70	78	87	103	121	90	125	125	125	150	-
Height – H4	H max. [mm]	310	487	502	521	625	662	310	487	502	521	625	662
Height – H8 double piston design	H max. [mm]	318	514	529	548	687	724	318	514	529	548	687	724
Clamp connections		Inlet a						Outlet b					
	PN	16	16	16	10	10	10	16	10	10	10	10	10
Center to face	[mm]	75	92	99	109	124	149	112	147	147	153	178	181
Clamp diameter	d_{inner} [mm] d_{outer} [mm]	For varying clamp diameters please refer to page 16 and 17						For varying clamp diameters please refer to page 16 and 17					
Height – H4	H max. [mm]	331	509	524	543	646	690	331	509	524	543	646	690
Height – H8 double piston design	H max. [mm]	339	536	551	570	709	752	339	536	551	570	709	752
Aseptic screwed connections		Inlet a						Outlet b					
	PN	40	40	25	25	25	25	40	25	25	25	16	16
Center to face	[mm]	93	110	106	117	133	151	130	155	155	155	185	-
Height – H4	H max. [mm]	349	527	530	551	655	692	349	527	530	551	655	692
Height – H8 double piston design	H max. [mm]	357	554	557	578	717	754	357	554	557	578	717	754
Aseptic flanged connections acc. to DIN 11684		Inlet a						Outlet b					
	PN	25	25	16	16	16	16	25	16	16	16	10	10
Center to face	[mm]	78	95	103	112	128	146	115	150	150	150	175	183
Height – H4	H max. [mm]	335	512	527	546	650	687	335	512	527	546	650	687
Height – H8 double piston design	H max. [mm]	343	539	554	573	712	749	343	539	554	573	712	749
Weight		Weight						Weight					
	max. [kg]	9	20	21,7	26,5	47	56						

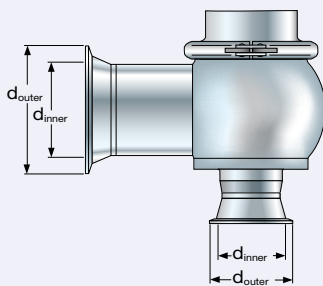

Clamp diameters

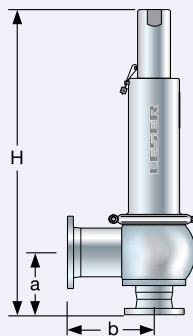

Flanged connection

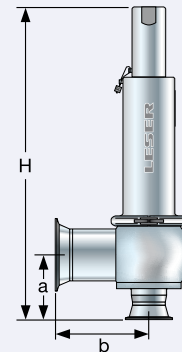

Clamp connection

Dimensions and weights

US Units

		0,906	1,457	1,811	2,362	2,913	3,622	0,906	1,457	1,811	2,362	2,913	3,622
Actual Orifice diameter d_0 [inch]		0,906	1,457	1,811	2,362	2,913	3,622	0,906	1,457	1,811	2,362	2,913	3,622
Actual Orifice area A_0 [inch ²]		0,644	1,67	2,576	4,38	6,666	10,30	0,644	1,67	2,576	4,38	6,666	10,30
Welded connections		Inlet a						Outlet b					
	PN	16	16	16	16	16	16	16	16	16	16	16	16
Center to face	[inch]	2 ³ / ₃₂	2 ³ / ₄	3 ¹ / ₁₆	3 ⁷ / ₁₆	4 ¹ / ₃₂	4 ³ / ₄	3 ¹⁷ / ₃₂	4 ¹⁵ / ₁₆	4 ¹⁵ / ₁₆	4 ¹⁵ / ₁₆	5 ¹⁴ / ₁₆	–
Height – H4	H max. [inch]	12 ³ / ₁₆	19 ³ / ₁₆	19 ³ / ₄	20 ¹ / ₂	24 ⁵ / ₈	16 ¹ / ₁₆	12 ³ / ₁₆	19 ³ / ₁₆	19 ³ / ₄	20 ¹ / ₂	24 ⁵ / ₈	16 ¹ / ₁₆
Height – H8 double piston design	H max. [inch]	12 ¹ / ₂	20 ¹ / ₄	20 ¹³ / ₁₆	21 ⁹ / ₁₆	27 ¹ / ₁₆	28 ¹ / ₂	12 ¹ / ₂	20 ¹ / ₄	20 ¹³ / ₁₆	21 ⁹ / ₁₆	27 ¹ / ₁₆	28 ¹ / ₂
Clamp connections		Inlet a						Outlet b					
	PN	16	16	16	10	10	10	16	16	16	10	10	10
Center to face	[inch]	2 ¹⁵ / ₁₆	3 ¹⁹ / ₃₂	3 ²⁹ / ₃₂	4 ⁹ / ₃₂	4 ⁷ / ₈	5 ⁷ / ₈	4 ³ / ₈	5 ²⁵ / ₃₂	5 ²⁵ / ₃₂	6	7	7 ¹ / ₈
Clamp diameter	d_{inner} [inch]	For varying clamp diameters please refer to page 16 and 17						For varying clamp diameters please refer to page 16 and 17					
	d_{outer} [inch]												
Height – H4	H max. [inch]	13 ¹ / ₁₆	20 ¹ / ₁₆	20 ⁵ / ₈	21 ³ / ₈	25 ⁷ / ₁₆	27 ³ / ₁₆	13 ¹ / ₁₆	20 ¹ / ₁₆	20 ⁵ / ₈	21 ³ / ₈	25 ⁷ / ₁₆	27 ³ / ₁₆
Height – H8 double piston design	H max. [inch]	13 ³ / ₈	21 ¹ / ₈	21 ¹¹ / ₁₆	22 ⁷ / ₁₆	27 ¹⁵ / ₁₆	29 ⁵ / ₈	13 ³ / ₈	21 ¹ / ₈	21 ¹¹ / ₁₆	22 ⁷ / ₁₆	27 ¹⁵ / ₁₆	29 ⁵ / ₈
Aseptic screwed connections		Inlet a						Outlet b					
	PN	40	40	25	25	25	25	40	25	25	25	16	16
Center to face	[inch]	3 ²¹ / ₃₂	4 ⁵ / ₁₆	4 ¹ / ₈	4 ⁵ / ₈	5 ³ / ₁₆	5 ¹⁵ / ₁₆	5 ¹ / ₈	6 ¹ / ₈	6 ¹ / ₈	6 ¹ / ₈	7 ⁹ / ₃₂	–
Height – H4	H max. [inch]	13 ³ / ₄	20 ³ / ₄	20 ⁷ / ₈	21 ¹¹ / ₁₆	25 ¹³ / ₁₆	27 ¹ / ₄	13 ³ / ₄	20 ³ / ₄	20 ⁷ / ₈	21 ¹¹ / ₁₆	25 ¹³ / ₁₆	27 ¹ / ₄
Height – H8 double piston design	H max. [inch]	14 ¹ / ₁₆	21 ¹³ / ₁₆	21 ¹⁵ / ₁₆	22 ³ / ₄	28 ¹ / ₄	29 ¹¹ / ₁₆	14 ¹ / ₁₆	21 ¹³ / ₁₆	21 ¹⁵ / ₁₆	22 ³ / ₄	28 ¹ / ₄	29 ¹¹ / ₁₆
Aseptic flanged connections acc. to DIN 11684		Inlet a						Outlet b					
	PN	25	25	16	16	16	16	25	16	16	16	10	10
Center to face	[inch]	3 ¹ / ₁₆	3 ³ / ₄	4 ¹ / ₁₆	4 ⁷ / ₁₆	5	5 ³ / ₄	4 ¹ / ₂	5 ⁷ / ₈	5 ⁷ / ₈	5 ⁷ / ₈	6 ⁷ / ₈	7 ³ / ₁₆
Height – H4	H max. [inch]	13 ³ / ₁₆	20 ³ / ₁₆	20 ³ / ₄	21 ¹ / ₂	25 ⁹ / ₁₆	27 ¹ / ₁₆	13 ³ / ₁₆	20 ³ / ₁₆	20 ³ / ₄	21 ¹ / ₂	25 ⁹ / ₁₆	27 ¹ / ₁₆
Height – H8 double piston design	H max. [inch]	13 ¹ / ₂	21 ¹ / ₄	21 ¹³ / ₁₆	22 ⁹ / ₁₆	28 ¹ / ₁₆	29 ¹ / ₂	13 ¹ / ₂	21 ¹ / ₄	21 ¹³ / ₁₆	22 ⁹ / ₁₆	28 ¹ / ₁₆	29 ¹ / ₂
Weight													
Weight	max. [lb]	19,8	44,1	47,8	58,4	103,6	123,5						

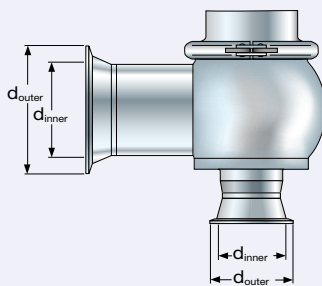

Clamp diameters

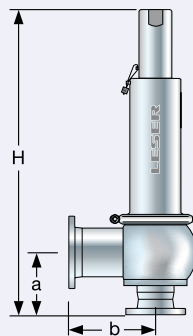

Flanged connection

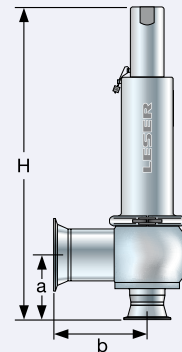

Clamp connection

Dimensions and weights

Metric Units

Actual Orifice diameter d_0 [mm]		23	37	46	60	74	92	23	37	46	60	74	92	
Actual Orifice area A_0 [mm ²]		416	1075	1662	2827	4301	6648	416	1075	1662	2827	4301	6648	
DIN / ASME Flange		Inlet a						Outlet b						
PN		16	16	16	16	16	16	16	16	16	16	16	16	
Center to face		[mm]	91	112	123	132	153	173	132	170	175	177	179	184
Height – H4		H max. [mm]	348	529	547	566	675	714	348	529	547	566	675	714
Height – H8 double piston design		H max. [mm]	356	556	574	593	737	776	356	556	574	593	737	776
APV Flange		Inlet a						Outlet b						
PN		10	10	10	10	10	10	10	10	10	10	10	10	
Center to face		[mm]	77	94	102	111	127	145	114	149	149	149	177	–
Height – H4		H max. [mm]	334	511	526	545	649	686	334	511	526	545	649	686
Height – H8 double piston design		H max. [mm]	342	538	553	572	711	748	342	538	553	572	711	748
Tuchenhagen Varivent Connections		Inlet a						Outlet b						
PN		10	10	10	10	10	10	–	–	–	–	–	–	
Center to face		[mm]	90	107	115	124	140	158	–	–	–	–	–	
Height – H4		H max. [mm]	347	524	539	558	662	699	347	524	539	558	662	699
Height – H8 double piston design		H max. [mm]	355	551	566	585	724	761	355	551	566	585	724	761
Weight		Inlet a						Outlet b						
Weight		max. [kg]	9	20	21,7	26,5	47	56	–	–	–	–	–	

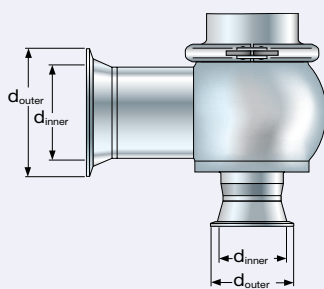

Clamp diameters

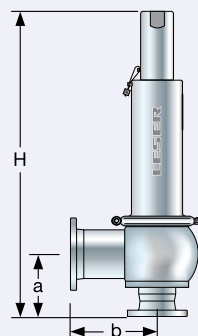

Flanged connection

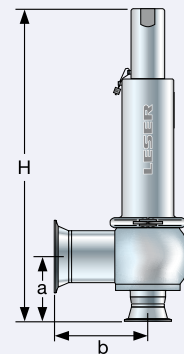

Clamp connection

Dimensions and weights

US Units															
Actual Orifice diameter d_0 [inch]		23	37	46	60	74	92	23	37	46	60	74	92		
Actual Orifice area A_0 [inch ²]		416	1075	1662	2827	4301	6648	416	1075	1662	2827	4301	6648		
DIN / ASME Flange		Inlet a						Outlet b							
	PN	16	16	16	16	16	16	16	16	16	16	16	16		
Center to face	[inch]	3 ⁹ / ₁₆	4 ⁷ / ₁₆	4 ¹³ / ₁₆	5 ³ / ₁₆	6	6 ¹³ / ₁₆	5 ³ / ₁₆	6 ¹¹ / ₁₆	6 ⁷ / ₈	6 ¹⁵ / ₁₆	7 ¹ / ₁₆	7 ¹ / ₄		
Height – H4	H max. [inch]	13 ¹¹ / ₁₆	20 ¹³ / ₁₆	21 ⁹ / ₁₆	22 ⁵ / ₁₆	26 ⁹ / ₁₆	28 ¹ / ₈	13 ¹¹ / ₁₆	20 ¹³ / ₁₆	21 ⁹ / ₁₆	22 ⁵ / ₁₆	26 ⁹ / ₁₆	28 ¹ / ₈		
Height – H8 double piston design	H max. [inch]	14	21 ⁷ / ₈	22 ⁵ / ₈	23 ³ / ₈	29	30 ⁹ / ₁₆	14	21 ⁷ / ₈	22 ⁵ / ₈	23 ³ / ₈	29	30 ⁹ / ₁₆		
APV Flange		Inlet a						Outlet b							
	PN	10	10	10	10	10	10	10	10	10	10	10	10		
Center to face	[inch]	13 ¹ / ₁₆	13 ¹¹ / ₁₆	4	4 ³ / ₈	5	5 ¹¹ / ₁₆	4 ¹ / ₂	5 ⁷ / ₈	5 ⁷ / ₈	5 ⁷ / ₈	6 ¹⁵ / ₁₆	–		
Height – H4	H max. [inch]	13 ¹ / ₈	20 ¹ / ₈	20 ¹¹ / ₁₆	21 ⁷ / ₁₆	25 ⁹ / ₁₆	27	13 ¹ / ₈	20 ¹ / ₈	20 ¹¹ / ₁₆	21 ⁷ / ₁₆	25 ⁹ / ₁₆	27		
Height – H8 double piston design	H max. [inch]	13 ⁷ / ₈	21 ³ / ₁₆	21 ³ / ₄	22 ¹ / ₂	28	29 ⁷ / ₁₆	13 ⁷ / ₈	21 ³ / ₁₆	21 ³ / ₄	22 ¹ / ₂	28	29 ⁷ / ₁₆		
Tuchenhagen Varivent Connections		Inlet a						Outlet b							
	PN	10	10	10	10	10	10	–	–	–	–	–	–		
Center to face	[inch]	3 ⁹ / ₁₆	4 ³ / ₁₆	4 ¹ / ₂	4 ⁷ / ₈	5 ¹ / ₂	6 ¹ / ₄	–	–	–	–	–	–		
Height – H4	H max. [inch]	13 ¹¹ / ₁₆	20 ⁵ / ₈	21 ¹ / ₄	21 ¹⁵ / ₁₆	26 ¹ / ₁₆	27 ¹ / ₂	13 ¹¹ / ₁₆	20 ⁵ / ₈	21 ¹ / ₄	21 ¹⁵ / ₁₆	26 ¹ / ₁₆	27 ¹ / ₂		
Height – H8 double piston design	H max. [inch]	14	21 ¹¹ / ₁₆	22 ⁵ / ₁₆	23 ¹ / ₁₆	28 ¹ / ₂	29 ¹⁵ / ₁₆	14	21 ¹¹ / ₁₆	22 ⁵ / ₁₆	23 ¹ / ₁₆	28 ¹ / ₂	29 ¹⁵ / ₁₆		
Weight															
Weight	max. [lb]	19,8	44,1	47,8	58,4	103,6	123,5								

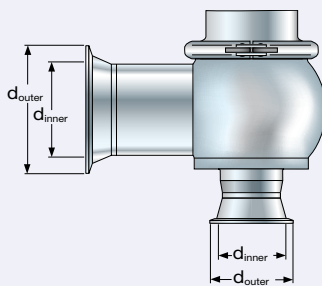

Clamp diameters

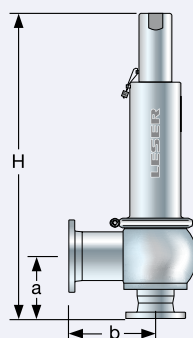

Flanged connection

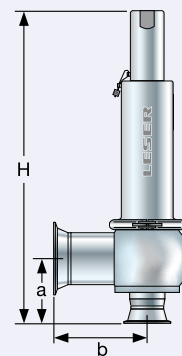

Clamp connection

Pressure temperature ratings

Metric Units													
Actual Orifice diameter d_0 [mm]		23	37	46	60	74	92						
Actual Orifice area A_0 [mm ²]		416	1075	1662	2827	4301	6648						
Body material: 1.4404 (316L)													
Inlet / Outlet	Pressure rating	For pressure ratings and connection size please refer to chapter dimensions and weights (page 48/50)											
Minimum set pressure¹⁾	p [bar] S/G/L	0,1	0,1	0,2	0,1	0,1	0,1						
Maximum set pressure	p [bar] S/G/L	16	16	15	10,34	10,34	8,2						
Temperature range²⁾		Min.	Max.	Min.	Max.	Min.	Max.	Min.	Max.	Min.	Max.	Min.	Max.
EPDM	[°C]	-45	+150	-45	+150	-45	+150	-45	+150	-45	+150	-45	+150
CR	[°C]	-40	+100	-40	+100	-40	+100	-40	+100	-40	+100	-40	+100
FKM	[°C]	-20	+180	-20	+180	-20	+180	-20	+180	-20	+180	-20	+180
FFKM	[°C]	0	+250	0	+250	0	+250	0	+250	0	+250	0	+250

US Units													
Actual Orifice diameter d_0 [inch]		0,906	1,457	1,811	2,362	2,913	3,622						
Actual Orifice area A_0 [inch ²]		0,644	1,667	2,576	4,383	6,666	10,304						
Body material: 1.4404 (316L)													
Inlet / Outlet	Pressure rating	For pressure ratings and connection size please refer to chapter dimensions and weights (page 49/51)											
Minimum set pressure¹⁾	p [psig] S/G/L	1,5	1,5	3	1,5	1,5	1,5						
Maximum set pressure	p [psig] S/G/L	232	232	217,56	150	150	118,9						
Temperature range²⁾		Min.	Max.	Min.	Max.	Min.	Max.	Min.	Max.	Min.	Max.	Min.	Max.
EPDM	[°F]	-49	+302	-49	+302	-49	+302	-49	+302	-49	+302	-49	+302
CR	[°F]	-40	+212	-40	+212	-40	+212	-40	+212	-40	+212	-40	+212
FKM	[°F]	-4	+356	-4	+356	-4	+356	-4	+356	-4	+356	-4	+356
FFKM	[°F]	+32	+482	+32	+482	+32	+482	+32	+482	+32	+482	+32	+482

¹⁾ For steam, air/gas starting from 1,38 bar (20 psig) the safety valve is certified acc. to ASME Code Sec. VIII, Div. 1.

For liquides starting from 1 bar (15 psig) the safety valve is certified acc. to ASME Code Sec. VIII, Div. 1.

²⁾ The temperature is limited by the soft seal material.

Selection chart H8

Depending on the set pressure and lifting pressure (air supply) a double piston lifting device (option code J41) may be required instead of a single piston. The chart below determines the required lifting device.

Selection chart lifting device H8, size I. d_0 23 mm / 0,906 inch

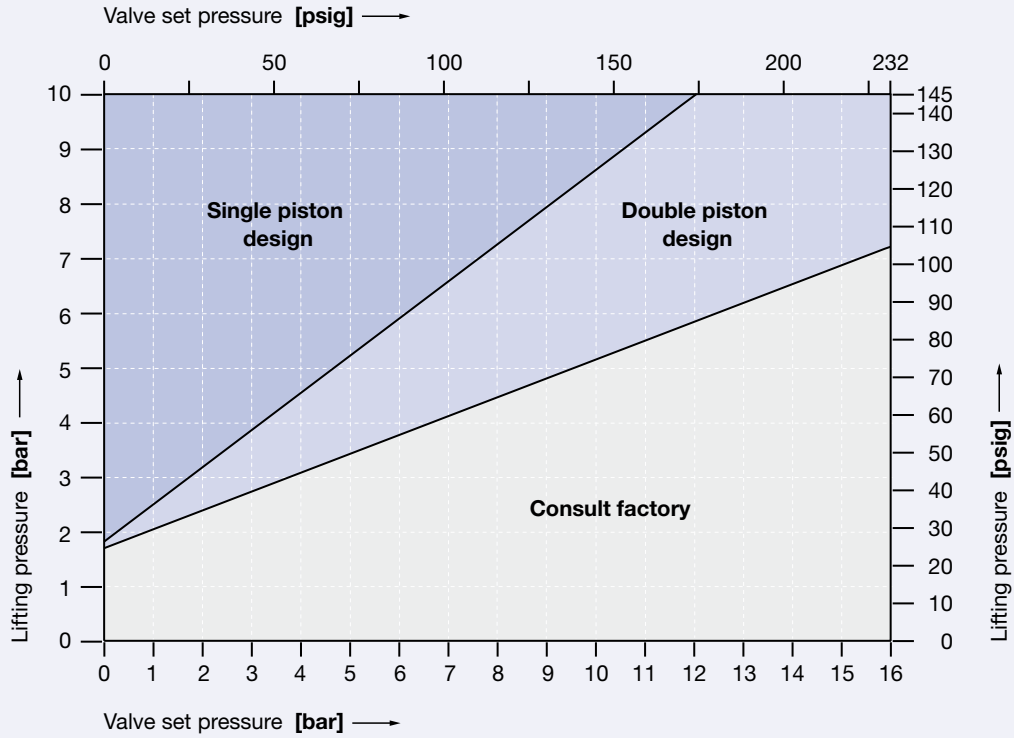

Selection chart lifting device H8, size II. d_0 37 mm / 1,457 inch

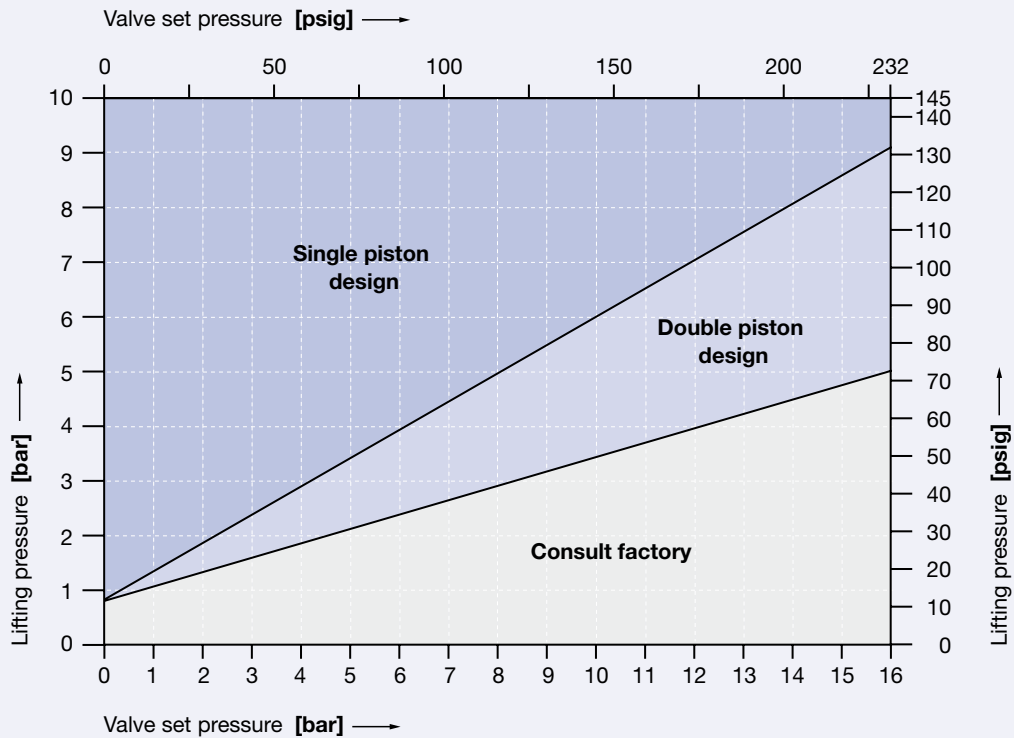

Selection chart H8

Selection chart lifting device H8, size II. d_0 46 mm / 1,811 inch

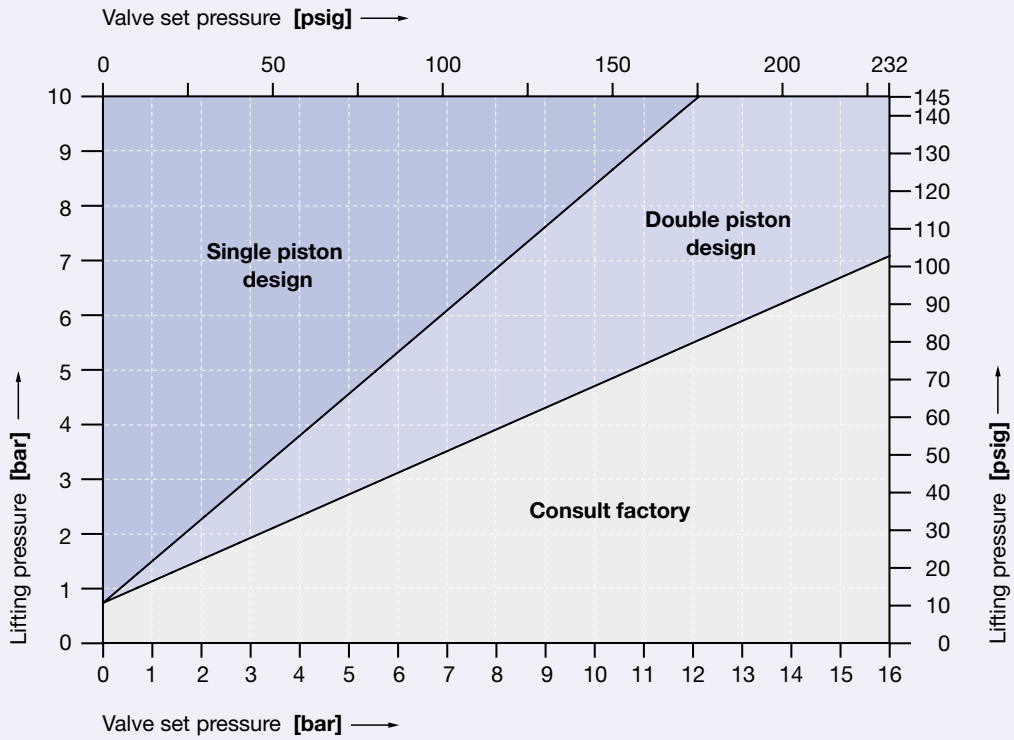

Selection chart lifting device H8, size II. d_0 60 mm / 2,362 inch

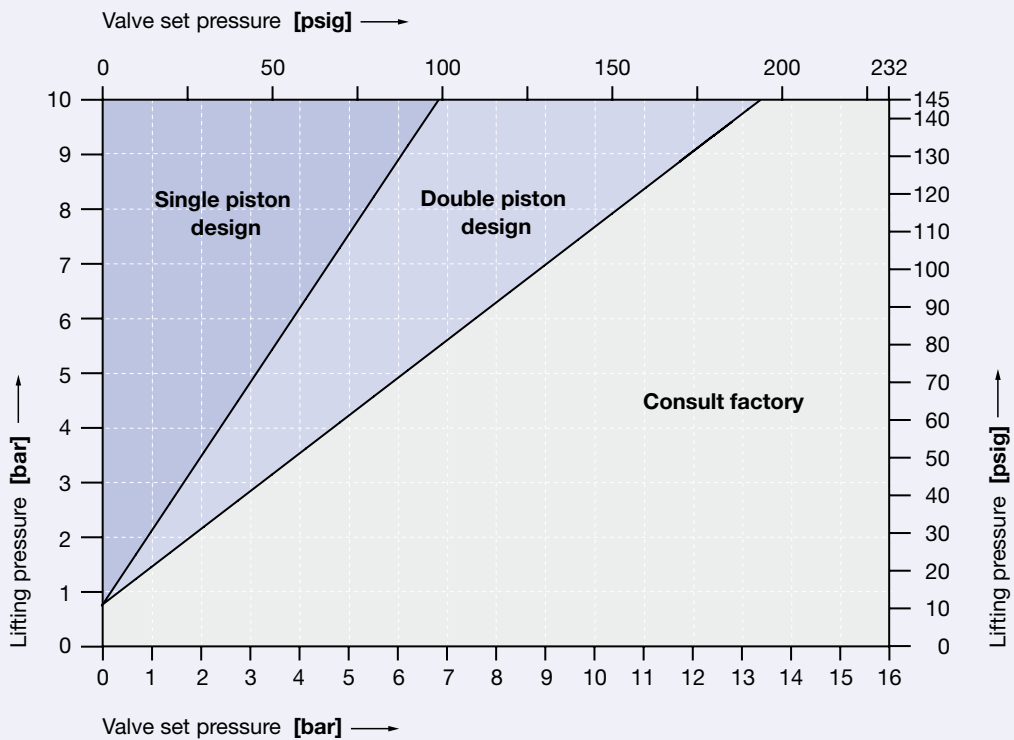

Type 488

Selection chart H8

Selection chart lifting device H8, size III. d_0 74 mm / 2,913 inch

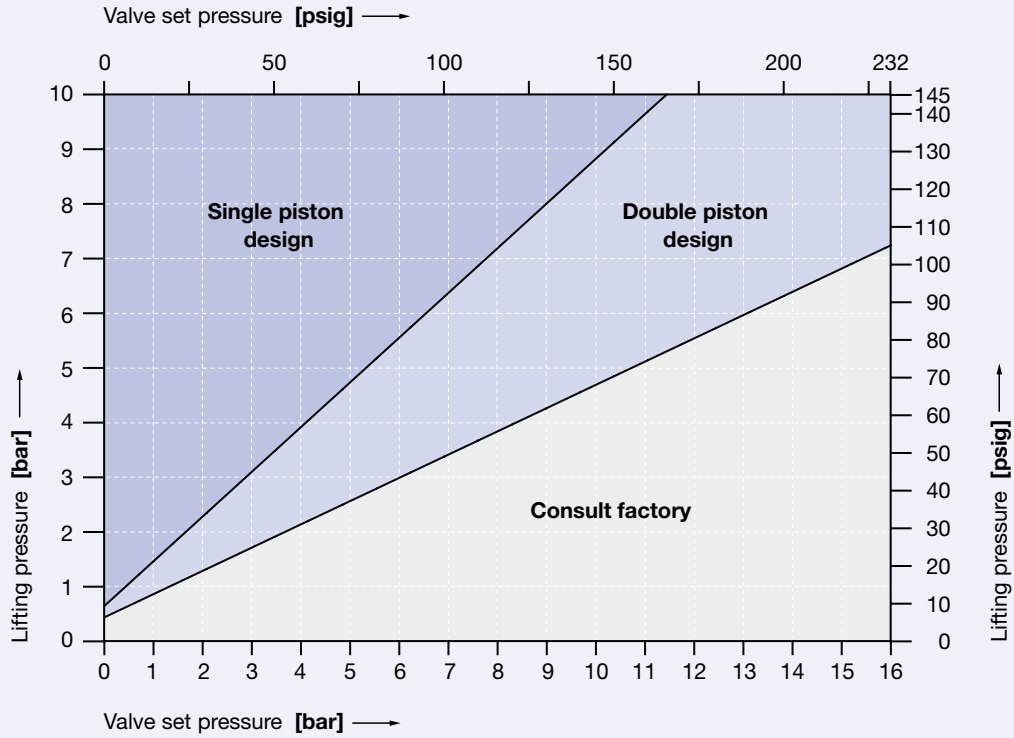

Selection chart lifting device H8, size III. d_0 92 mm / 3,622 inch

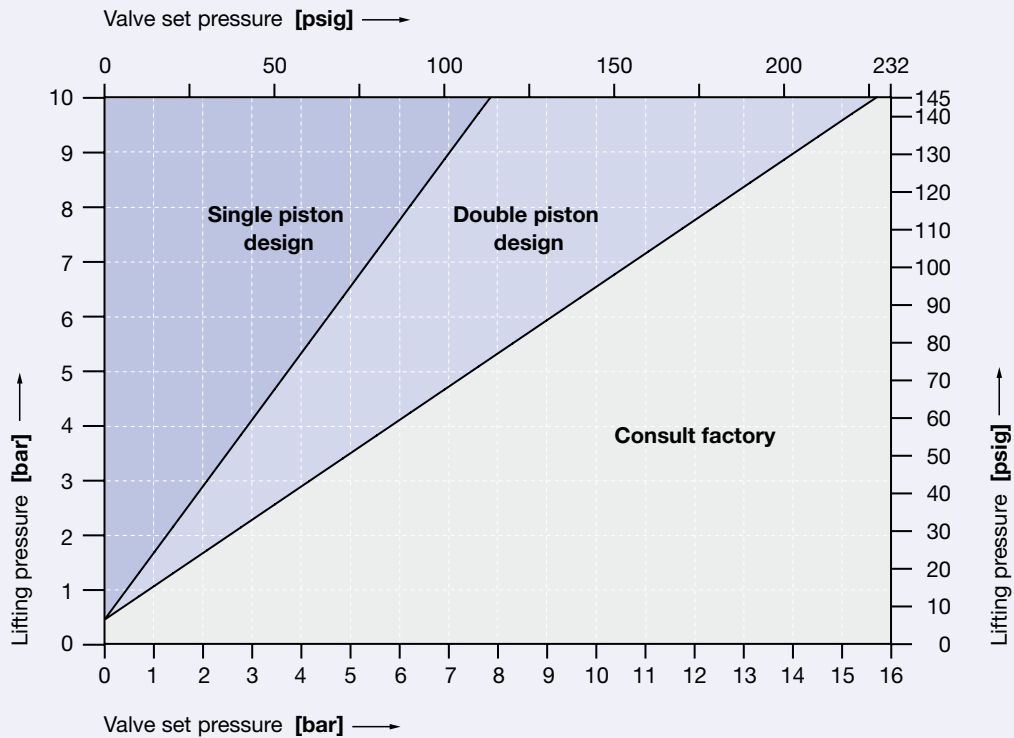

Surface quality

Surface quality			LESER Surface package			
Type of surface	Area		Option code	Clean finish	HyClean finish	Sterile finish
	Description	No.		B68	B69	B70
				R _a max.	R _a max.	R _a max.
LESER Surface grade						
Product contact surface	Inlet	1	[μm]	M4 0,750	ME4 0,750	ME1 0,375
			[μinch]	30	30	15
	Bottom side of disc	2	[μm]	M4 0,750	ME4 0,750	ME1 0,375
			[μinch]	30	30	15
Blow off surface	Inside surface of outlet area	3	[μm]	M5 1,500	ME5 1,500	ME4 0,750
			[μinch]	60	60	30
	Welding seam	4	[μm]	M6 3,000	ME6 3,000	ME6 3,000
			[μinch]	120	120	120
Outer surface	Outside surface of body, bonnet and cap/lifting device	5	[μm]	M5 1,500	ME5 1,500	ME5 1,500
			[μinch]	60	60	60
Shielded surface	Surface never in contact with the product because it is shielded by the bellows	6		No definition		

If required surface deviates from standard specify No. and required LESER Surface Grade.

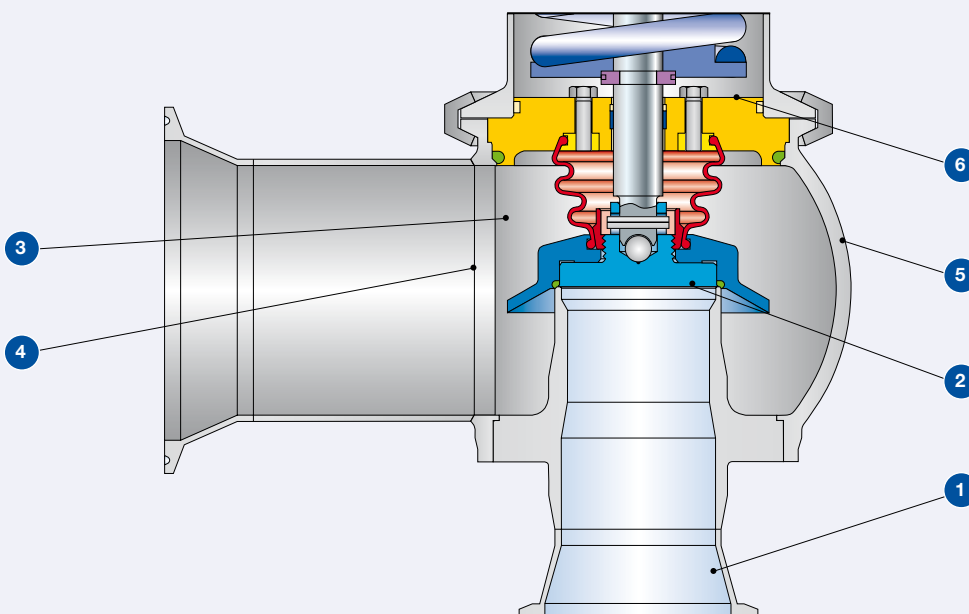

Approvals

Approvals						
Actual Orifice diameter d_0 [mm]	23	37	46	60	74	92
Actual Orifice area A_0 [mm ²]	416	1075	1662	2827	4301	6648
Actual Orifice diameter d_0 [inch]	0,906	1,457	1,811	2,362	2,913	3,622
Actual Orifice area A_0 [inch ²]	0,644	1,667	2,576	4,383	6,666	10,304
Europe			Coefficient of discharge K_{dr}			
DIN EN ISO 4126-1	Approval No.	07 202 0111 Z 0008/0/25				
	S/G	0,7				
	L	0,45				
Germany			Coefficient of discharge α_w			
AD 2000-Merkblatt A2	Approval No.	TÜV SV 1047				
	S/G	0,7				
	L	0,45				
United States			Coefficient of discharge K			
ASME Sec. VIII	Approval No.	M37022 (1,37 – 16 bar)				
	S/G	0,721				
	Approval No.	M37033 (1 – 16 bar)				
	L	0,472				
Canada			Coefficient of discharge K			
CRN	Approval No.	OG0772.9C				
	S/G	0,721				
	L	0,472				
China			Coefficient of discharge α_w			
AQSIQ	Approval No.	02301T				
	S/G	0,7				
	L	0,45				
Eurasian Custom Union			Coefficient of discharge α_w			
EAC	Approval No.	For current approval no. see www.leser.com				
	S/G	0,7				
	L	0,45				
Classification societies			on request			

Available options

Gastight cap H2
H2

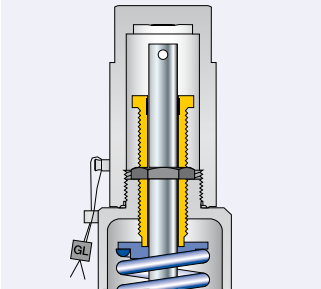

Gastight lifting device H4
Packed knob H4 (d_0 23 only)

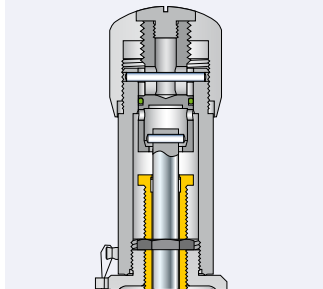

Packed lever H4
(for $d_0 > 23$)

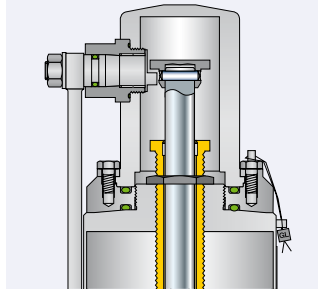

Pneumatic lifting device H8
H8 single piston design

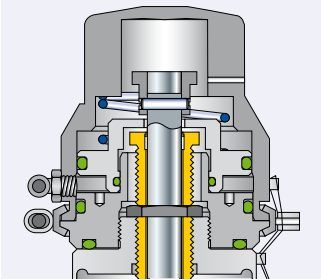

Pneumatic lifting device H8
J41: H8 double piston design

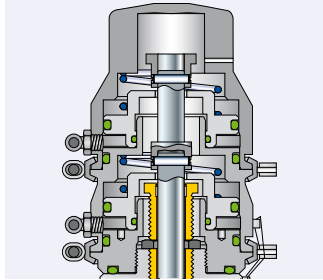

HyTight Assembly

- J22: EPDM "D"
- J21: CR "K"
- J23: FKM "L"
- J20: FFKM "C"

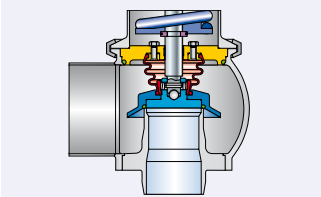

Test gag
(for $d_0 > 23$)
J69: H4

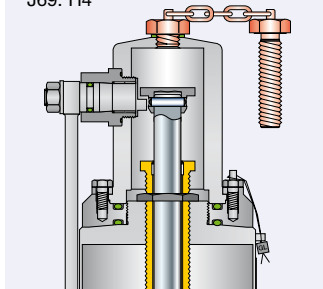

Test gag
J70: H2

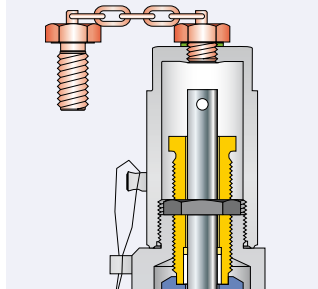

Lift indicator bonnet
(d_0 23 only)
J38 + J93

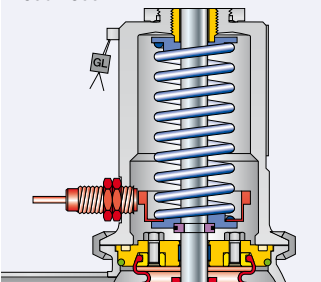

Lift indicator H4
(for $d_0 > 23$)
J39 + J93

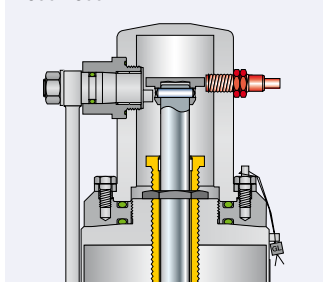

Lift indicator H8
(for $d_0 > 23$)
J40 + J93

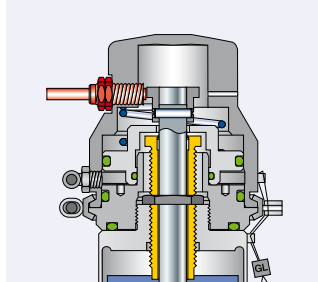

Multiple possibilities of aseptic connections

- Dairy industry coupling
- Sterile screw coupling
- Small flange
- Clamp

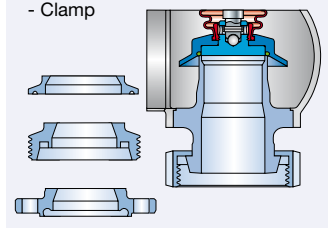



Type 484
Cap H2
Inlet: Vessel connection
Type 5034
Outlet: Welded end connection

Type 484

Safety Relief Valves – spring loaded



Type 484
Packed knob H4
Inlet: Vessel connection
Type 5034
Outlet: Welded end connection

Contents

Page

Materials

- HyTight Assembly 60

How to order

- Article numbers 62
- Available connections 63

Dimensions and weights

- Metric Units 64
- US Units 65

Pressure temperature ratings

- Metric Units + US Units 66

Selection chart H8 67

Surface quality 68

Approvals 69

Available options 70



Type 5034
Vessel connection

HyTight Assembly

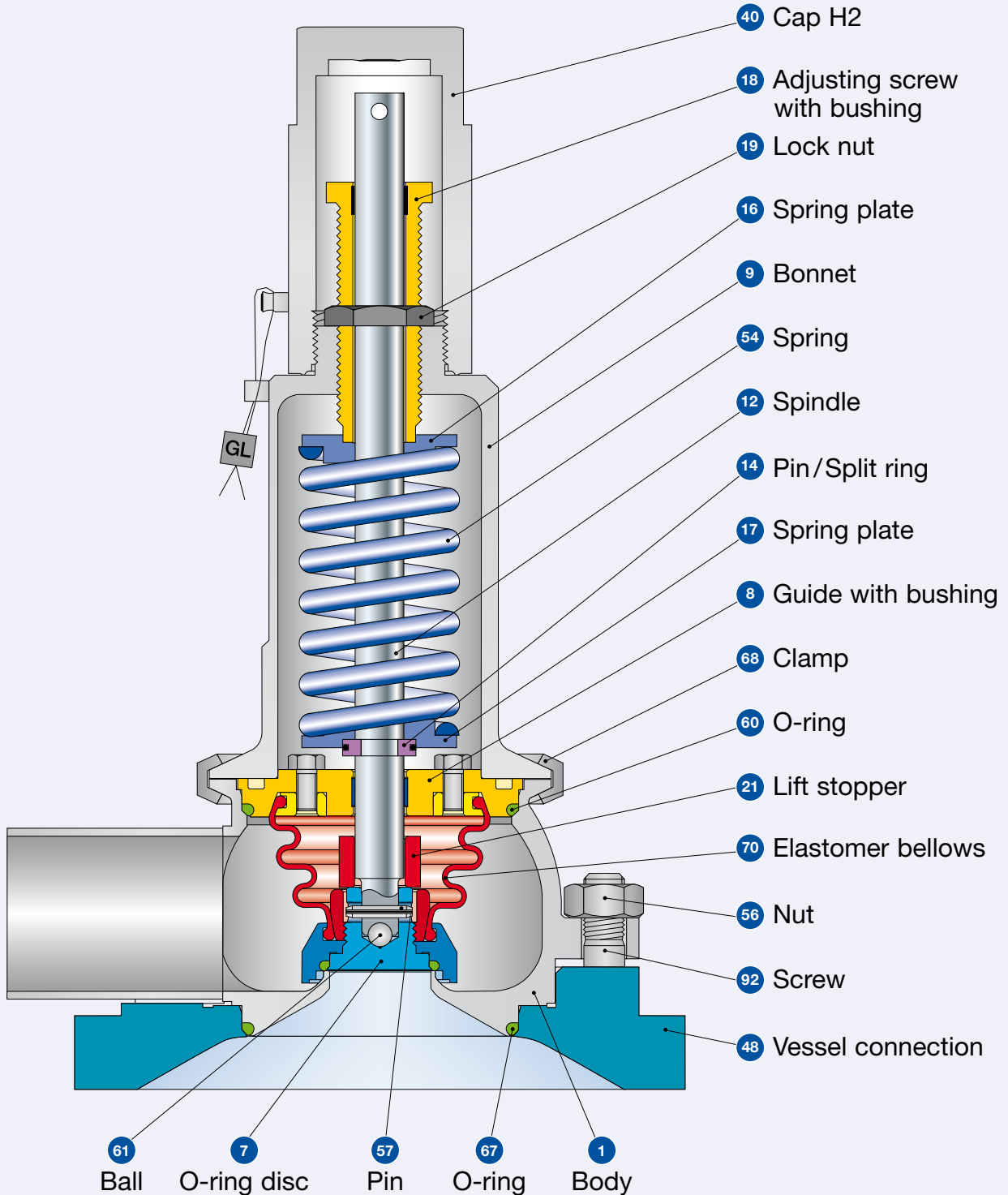





Type 484 HyTight

Cap H2

Inlet: Vessel connection Type 5034

Outlet: Welded end connection

Materials		HyTight Assembly	
Item	Component	Remarks	Type 4844 HyTight
1	Body		1.4435 (BN 2) ^{*)} SA 479 316L
7	O-ring disc	HyTight Assembly	1.4435 316L
7.4	Soft seal O-ring	"D" 	EPDM
		"C" 	FFKM
8	Guide with bushing	PTFE + 15 % glass	1.4435 316L
9	Bonnet		1.4404 316L
12	Spindle		1.4404 316L
14	Pin/Split ring		1.4310 / 1.4404 Stainless steel / 316L
16 / 17	Spring plate		1.4404 316L
18	Adjusting screw with bushing	PTFE + 15 % glass	1.4404 / PTFE 316L / PTFE
19	Lock nut		1.4404 316L
21	Lift stopper		1.4310 Stainless steel
40	Cap H2		1.4404 316L
54	Spring		1.4310 Stainless steel
57	Pin		1.4310 Stainless steel
60	O-ring		EPDM
61	Ball		1.4401 316
68	Clamp		1.4401 316
70	Elastomer bellows		EPDM
Vessel connection Type 5034			
48	Vessel connection		1.4435 (BN 2) ^{*)} SA 479 316L
56	Nut		1.4401 316
67	O-ring		EPDM
92	Screw		1.4404 316L
-	Blind flange for pressure test		1.4404 316L

^{*)} The material 1.4435/SA 479 316L fulfils the requirements of the Swiss chemical and pharmaceutical industry Basler Norm (BN 2).

Please notice: – Modifications reserved by LESER.
 – LESER can upgrade materials without notice.
 – Every part can be replaced by other material acc. to customer specification.

Article numbers

Article numbers				
Actual Orifice diameter d_0 [mm]		13		25
Actual Orifice area A_0 [mm ²]		133		491
Actual Orifice diameter d_0 [inch]		0,512		0,984
Actual Orifice area A_0 [inch ²]		0,206		0,761
O-ring material		EPDM "D" J22		EPDM "D" J22
		FFKM "C" J20		FFKM "C" J20
Body material: 1.4435 (316L)				
Bonnet closed	H2	Art.-No. 4844.	7722	7732
	H4	Art.-No. 4844.	7724	7734
	H8	Art.-No. 4844.	7728	7738
	p [bar] S/G/L		0,3 – 16	0,1 – 16
	p [psig] S/G/L		4,4 – 232	1,5 – 232
Vessel connection material: 1.4435 (316L)		Please order separately		
Vessel wall thickness [mm]	≤ 5	$> 5 \leq$	≤ 5	> 5
Vessel wall thickness [inch]	$\leq \frac{13}{64}$	$> \frac{13}{64}$	$\leq \frac{13}{64}$	$> \frac{13}{64}$
Art.-No. 5034.	0980	0981	0982	0983
Blind flange for pressure test: 1.4404 (316L)		Please order separately		
Art.-No.	138.8849.9000		138.8649.9000	

Fitting information

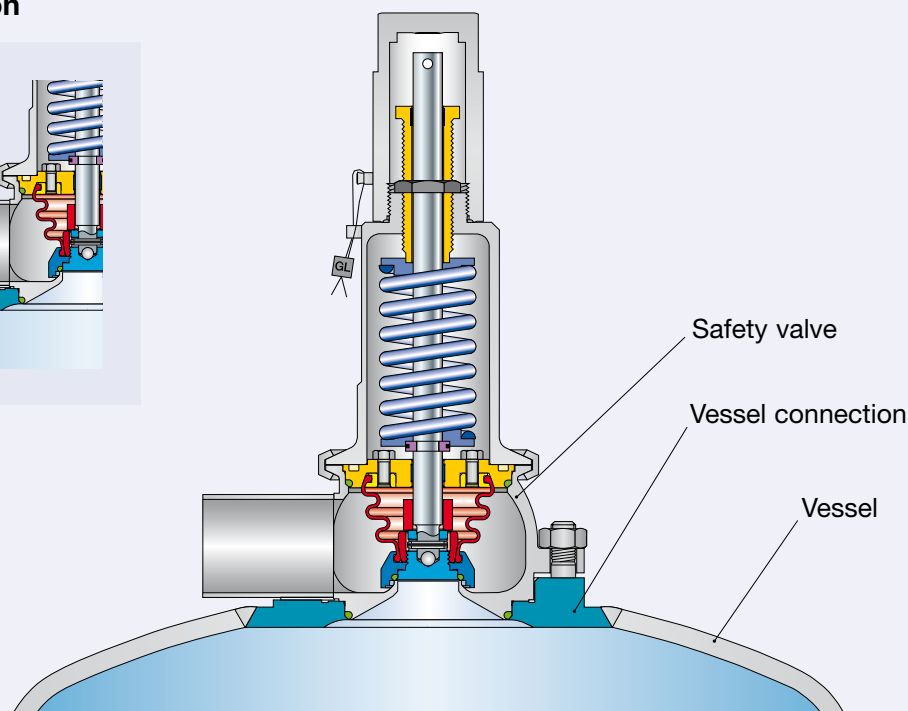
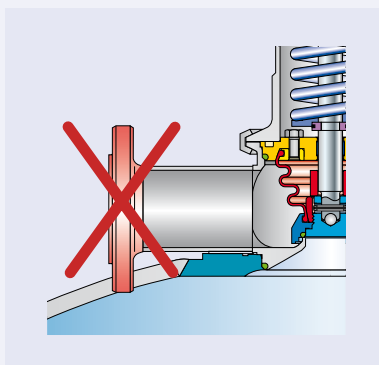

Due to the dead space free vessel connection, which is directly welded into the vessel wall, please note the required space between outlet connection of the valve (e. g. clamps or flanges) and vessel wall. If required please order a longer outlet connection with your specifications.

Available connections

Available connections

Clamps

Option code inlet

For inlet please select vessel connection
Type 5034 as shown on page 62.
For connections directly machined into vessel wall
please ask for drawing.

Aseptic screwed connection

Option code inlet

Aseptic flanged connection

Option code inlet

d _o [mm]	13	25
A _o [mm ²]	133	491

Clamps

Option code outlet

DN	25	40
SO	L86A16	L86A17
DO	I74A16	I71A17
NPS	1 1/2"	2"
BO	I76A80	I76A81
CO	L97A80	L97A81

Aseptic screwed connection

Option code outlet

Pipe standard	DN	25	40
DIN 11850 / DIN 11866 Range A	00	A85L83A16	A85L83A17
	GS	A85H35A16	A85H35A17
	BS	A85H37A16	A85H37A17
	GT	A85H55A16	A85H55A17
	BT	A85H57A16	A85H57A17
	GO	A85L81A16	A85L81A17
	KO	A85L82A16	A85L82A17
	GD	A85H61A16	A85H61A17
	BD	A85H59A16	A85H59A17

Pipe standard	DN	25	40
DIN EN ISO 1127 / DIN 11866 Range B	GS	A86H35A16	A86H35A17
	BS	A86H37A16	A86H37A17
	GT	A86H55A16	A86H55A17
	BT	A86H57A16	A86H57A17
	GD	A86H61A16	A86H61A17
	BD	A86H59A16	A86H59A17

Pipe standard	NPS	1 1/2"	2"
BS 4825-1 DIN 11866 Range C	GS	A84H35A80	A84H35A81
	BS	A84H37A80	A84H37A81
	GT	A84H55A80	A84H55A81
	BT	A84H57A80	A84H57A81

Aseptic flanged connection

Option code outlet

Pipe standard	DN	25	40
DIN 11850 / DIN 11866 Range A	NF	A85H72A16	A85H72A17
	BF	A85H74A16	A85H74A17
	NG	A85H76A16	A85H76A17
	BG	A85H78A16	A85H78A17
	TN	A85L84A16	A85L84A17
	AF	A85L91A16	A85L91A17
	AN	A85L93A16	A85L93A17

Pipe standard	DN	25	40
DIN EN ISO 1127 / DIN 11866 Range B	NF	A86H72A16	A86H72A17
	BF	A86H74A16	A86H74A17
	NG	A86H76A16	A86H76A17
	BG	A86H78A16	A86H78A17

Pipe standard	DN	1 1/2"	2"
BS 4825-1 DIN 11866 Range C	NF	A84H72A80	A84H72A81
	BF	A84H74A80	A84H74A81
	NG	A84H76A80	A84H76A81
	BG	A84H78A80	A84H78A81

For definitions of connection codes please refer to pages 12 up to 15.

Dimensions and weights

Metric Units						
Actual Orifice diameter d_0 [mm]			13		25	
Actual Orifice area A_0 [mm ²]			133		491	
Vessel connections			Vessel wall thickness		Vessel wall thickness	
			≤ 5 mm	> 5 mm	≤ 5 mm	> 5 mm
PN			16	16	16	16
Flange thickness	C	[mm]	12,0	12,0	12,0	12,0
	C ₁	[mm]	5,0	18,0	5,0	18,0
Diameter	D	[mm]	130,0	130,0	150,0	150,0
	D ₁	[mm]	110,0	110,0	127,0	127,0
Bolt circle	L	[mm]	90,0	90,0	110,0	110,0
Welded connections			Inlet a ¹⁾	Outlet b	Inlet a ¹⁾	Outlet b
PN			16	16	16	16
Center to face		[mm]	24	80	30	90
Height – H4	H max.	[mm]	201		289	
Height – H8 double piston design	H max.	[mm]	229		296	
Clamp connections			Inlet a ¹⁾	Outlet b	Inlet a ¹⁾	Outlet b
PN			16	16	16	16
Center to face		[mm]	24	102	30	112
Clamp diameter	d _{inner}	[mm]	For varying clamp diameters please refer to page 16 and 17			
	d _{outer}	[mm]	For varying clamp diameters please refer to page 16 and 17			
Height – H4	H max.	[mm]	201		289	
Height – H8 double piston design	H max.	[mm]	229		296	
Threaded connections			Inlet a ¹⁾	Outlet b	Inlet a ¹⁾	Outlet b
PN			16	16	16	16
Center to face		[mm]	24	120	30	130
Height – H4	H max.	[mm]	201		289	
Height – H8 double piston design	H max.	[mm]	229		296	
Flanged connections			Inlet a ¹⁾	Outlet b	Inlet a ¹⁾	Outlet b
PN			16	16	16	16
Center to face		[mm]	24	126	30	134
Height – H4	H max.	[mm]	201		289	
Height – H8 double piston design	H max.	[mm]	229		296	
Weight						
Weight	max.	[kg]	3,0		4,0	

¹⁾ without vessel connection

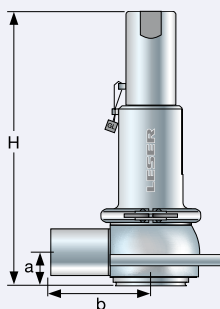

Type 484 – Cap H2

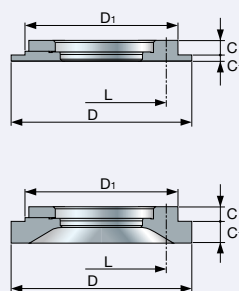

Type 5034 – Vessel connection

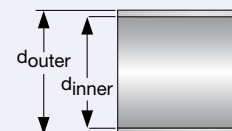

Tube end

Dimensions and weights

US Units						
Actual Orifice diameter d_0 [inch]			0,512		0,984	
Actual Orifice area A_0 [inch ²]			0,206		0,761	
Vessel connections			Vessel wall thickness		Vessel wall thickness	
			$\leq 13/64$ inch		$> 13/64$ inch	
			16		16	
Flange thickness	C	[inch]	$15/32$		$15/32$	
	C_1	[inch]	$11/16$		$23/32$	
Diameter	D	[inch]	$5 \frac{1}{8}$		$5 \frac{1}{8}$	
	D_1	[inch]	$4 \frac{11}{32}$		$4 \frac{11}{32}$	
Bolt circle	L	[inch]	$3 \frac{17}{32}$		$3 \frac{17}{32}$	
Welded connections			Inlet a ¹⁾		Outlet b	
			16		16	
Center to face		[inch]	$15/16$		$3 \frac{5}{32}$	
Height – H4	H max.	[inch]	$7 \frac{29}{32}$		$11 \frac{3}{8}$	
Height – H8 double piston design	H max.	[inch]	9		$11 \frac{5}{32}$	
Clamp connections			Inlet a ¹⁾		Outlet b	
			16		16	
Center to face		[inch]	$15/16$		4	
Clamp diameter	d_{inner}	[inch]	For varying clamp diameters please refer to page 16 and 17			
	d_{outer}	[inch]	For varying clamp diameters please refer to page 16 and 17			
Height – H4	H max.	[inch]	$7 \frac{29}{32}$		$11 \frac{3}{8}$	
Height – H8 double piston design	H max.	[inch]	9		$11 \frac{5}{32}$	
Threaded connections			Inlet a ¹⁾		Outlet b	
			16		16	
Center to face		[inch]	$15/16$		$4 \frac{23}{32}$	
Height – H4	H max.	[inch]	$7 \frac{29}{32}$		$11 \frac{3}{8}$	
Height – H8 double piston design	H max.	[inch]	9		$11 \frac{5}{32}$	
Flanged connections			Inlet a ¹⁾		Outlet b	
			16		16	
Center to face		[inch]	$15/16$		$4 \frac{15}{16}$	
Height – H4	H max.	[inch]	$7 \frac{29}{32}$		$11 \frac{3}{8}$	
Height – H8 double piston design	H max.	[inch]	9		$11 \frac{5}{32}$	
Weight						
Weight	max.	[lb]	6,6		8,8	

¹⁾ without vessel connection

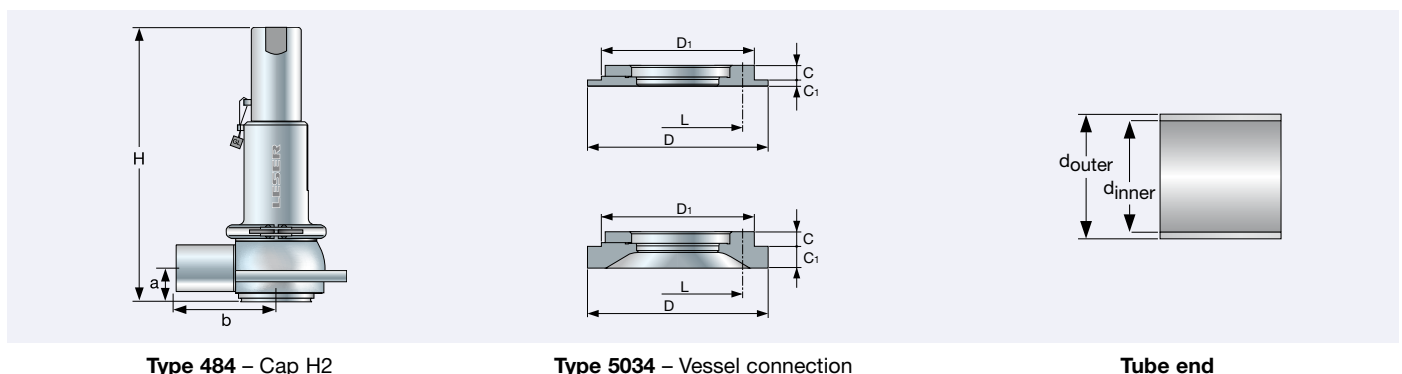

Pressure temperature ratings

Metric Units					
Actual Orifice diameter d_0 [mm]		13	25		
Actual Orifice area A_0 [mm ²]		133	491		
Body material: 1.4435 (316L)					
Minimum set pressure	p [bar] S/G/L	0,3		0,1	
Maximum set pressure	p [bar] S/G/L	16		16	
Temperature range ¹⁾		Minimum	Maximum	Minimum	Maximum
EPDM	[°C]	-45	+150	-45	+150
FFKM	[°C]	0	+250	0	+250

US Units					
Actual Orifice diameter d_0 [inch]		0,512	0,984		
Actual Orifice area A_0 [inch ²]		0,206	0,761		
Body material: 1.4435 (316L)					
Minimum set pressure	p [psig] S/G/L	4,4		1,5	
Maximum set pressure	p [psig] S/G/L	232		232	
Temperature range ¹⁾		Minimum	Maximum	Minimum	Maximum
EPDM	[°F]	-49	+302	-49	+302
FFKM	[°F]	+32	+482	+32	+482

¹⁾ The temperature is limited by the soft seal material.

Selection chart H8

Depending on the set pressure and lifting pressure (air supply) a double piston lifting device (option code J41) may be required instead of a single piston. The chart below determines the required lifting device.

Selection chart lifting device H8, size 0. d_0 13 mm / 0,512 inch

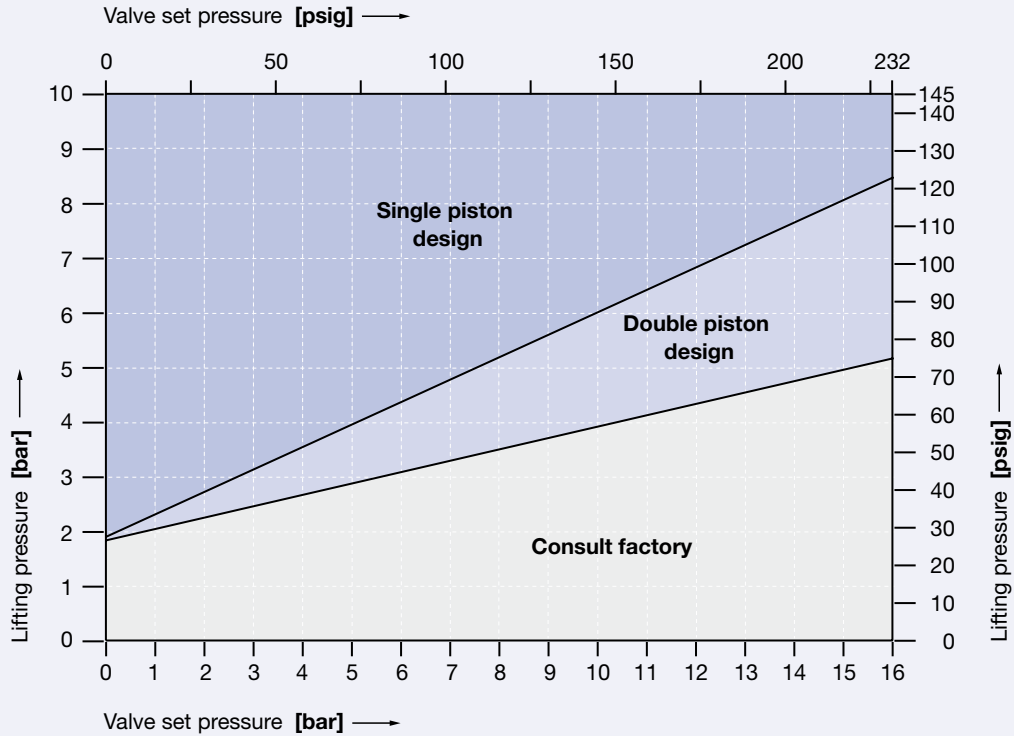

Selection chart lifting device H8, size I. d_0 25 mm / 0,984 inch

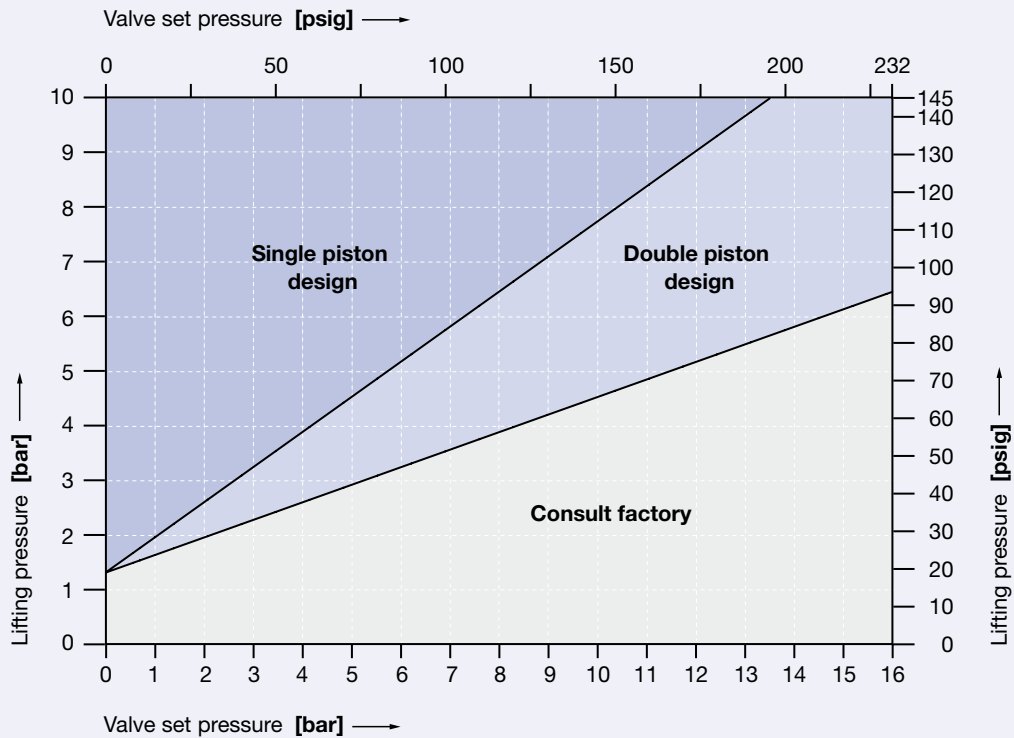

Surface quality

Surface quality			LESER Surface package			
Type of surface	Area		Option code	Clean finish	HyClean finish	Sterile finish
	Description	No.		B56	B57	B58
				R _a max.	R _a max.	R _a max.
LESER Surface grade						
Product contact surface	Inlet	1	[μm]	ME4 0,750	ME2 0,500	ME1 0,375
			[μinch]	30	20	15
	Bottom side of disc	2	[μm]	ME4 0,750	ME2 0,500	ME1 0,375
			[μinch]	30	20	15
Blow off surface	Inside surface of outlet area	3	[μm]	ME4 0,750	ME3 0,625	ME2 0,500
			[μinch]	30	25	20
	Welding seam	4	[μm]	ME6 3,000	ME5 1,500	ME4 0,750
			[μinch]	120	60	30
Outer surface	Outside surface of body, bonnet and cap/lifting device	5	[μm]	ME5 1,500	ME4 0,750	ME4 0,750
			[μinch]	60	30	30
Shielded surface	Surface never in contact with the product because it is shielded by the bellows	6		No definition		

Type 5034			Vessel connection			
			LESER Surface package			
Type of surface	Area		Option code	Clean finish	HyClean finish	Sterile finish
	Description	No.		B59	B60	B61
				R _a max.	R _a max.	R _a max.
LESER Surface grade						
Product contact surface	Vessel side	7	[μm]	M4 0,750	M2 0,500	M1 0,375
			[μinch]	30	20	15
Outer surface	Outside surface	8	[μm]	M5 1,500	M4 0,750	M4 0,750
			[μinch]	60	30	30

Caution: Electropolishing of the vessel connection is not reasonable before welding.

If required surface deviates from standard clean finish please specify option code and required LESER Surface package.

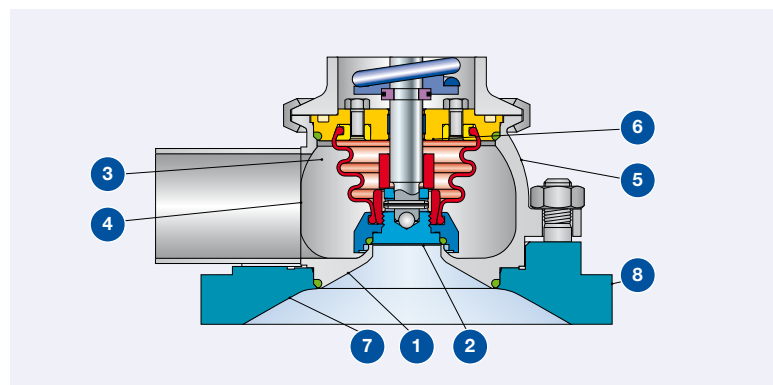

Approvals

Approvals		
Actual Orifice diameter d_0 [mm]	13	25
Actual Orifice area A_0 [mm ²]	133	491
Actual Orifice diameter d_0 [inch]	0,512	0,984
Actual Orifice area A_0 [inch ²]	0,206	0,761
Europe		Coefficient of discharge K_{dr}
DIN EN ISO 4126-1	Approval No.	07 202 0111 Z 0008/0/20
	S/G	0,60
	L	0,40
		0,41
		0,28
Germany		Coefficient of discharge α_w
AD 2000-Merkblatt A2	Approval No.	TÜV SV 1047
	S/G	0,60
	L	0,40
		0,41
		0,28
United States		Coefficient of discharge K
ASME Sec. VIII	Approval No.	M37145
	S/G	Rated slope acc. to ASME VIII, Div. 1 UG-131 (d) (2) S: 5,52 lb / hr / psia $\triangle K \approx 0,521$ G: 1,96 SCFM / psia $\triangle K \approx 0,521$
	L	Rated slope acc. to ASME VIII, Div. 1 UG-131 (d) (2) L: 2,96 GPM $\sqrt{\text{psid}^*)} \triangle K \approx 0,379$
		M37167
	S/G	Rated slope acc. to ASME VIII, Div. 1 UG-131 (d) (2) S: 13,97 lb / hr / psia $\triangle K \approx 0,357$ G: 4,96 SCFM / psia $\triangle K \approx 0,357$
	L	Rated slope acc. to ASME VIII, Div. 1 UG-131 (d) (2) L: 7,46 GPM $\sqrt{\text{psid}^*)} \triangle K \approx 0,258$
		M37178
	S/G	Rated slope acc. to ASME VIII, Div. 1 UG-131 (d) (2) S: 13,97 lb / hr / psia $\triangle K \approx 0,357$ G: 4,96 SCFM / psia $\triangle K \approx 0,357$
	L	Rated slope acc. to ASME VIII, Div. 1 UG-131 (d) (2) L: 7,46 GPM $\sqrt{\text{psid}^*)} \triangle K \approx 0,258$
Canada		Coefficient of discharge K
CRN	Approval No.	OG0772.9C
	S/G	Rated slope acc. to ASME VIII, Div. 1 UG-131 (d) (2) S: 5,52 lb / hr / psia $\triangle K \approx 0,521$ G: 1,96 SCFM / psia $\triangle K \approx 0,521$
	L	Rated slope acc. to ASME VIII, Div. 1 UG-131 (d) (2) L: 2,96 GPM $\sqrt{\text{psid}^*)} \triangle K \approx 0,379$
		OG0772.9C
	S/G	Rated slope acc. to ASME VIII, Div. 1 UG-131 (d) (2) S: 13,97 lb / hr / psia $\triangle K \approx 0,357$ G: 4,96 SCFM / psia $\triangle K \approx 0,357$
	L	Rated slope acc. to ASME VIII, Div. 1 UG-131 (d) (2) L: 7,46 GPM $\sqrt{\text{psid}^*)} \triangle K \approx 0,258$
China		Coefficient of discharge α_w
AQSIQ	Approval No.	02301T
	S/G	0,60
	L	0,40
		0,41
		0,28
Eurasian Custom Union		Coefficient of discharge α_w
EAC	Approval No.	For current approval no. see www.leser.com
	S/G	0,60
	L	0,40
		0,41
		0,28
Classification societies		
on request		

*) psid = Differential pressure P-P_d
P = absolute flow pressure [psia]
P_d = pressure at discharge from valve [psia]

Available options

Gastight cap H2
H2

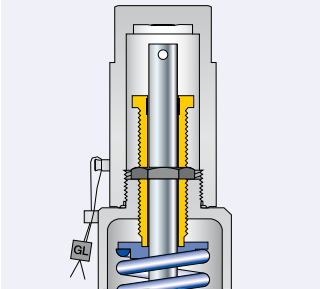

Gastight lifting device H4
Packed knob H4

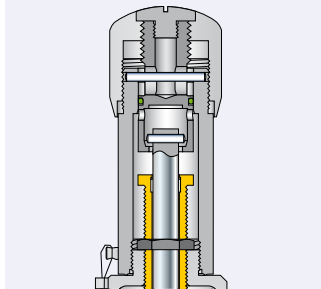



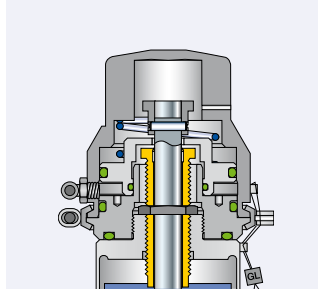

Pneumatic lifting device H8
H8 single piston design

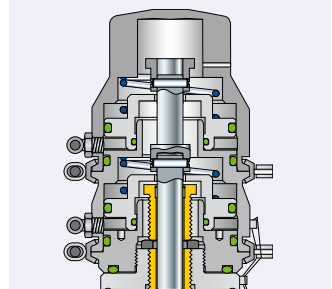

Pneumatic lifting device H8
J41: H8 double piston design



O-ring-disc

J22: EPDM "D"  
J20: FFKM "C"  

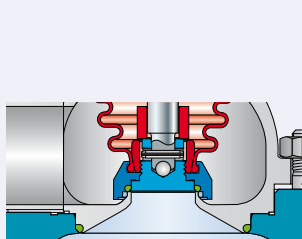

Bellows FFKM "C" 

S70 – only for d_0 13

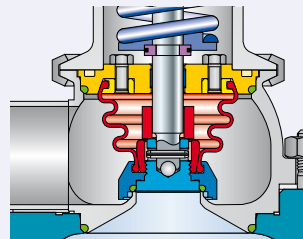

Blind flange for pressure test

Material-No. 138.8849.9000 (d_0 13)
Material-No. 138.8649.9000 (d_0 25)

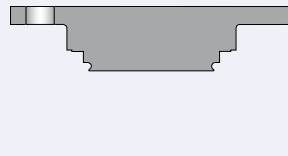

O-ring for vessel connection

EPDM "D" 
Material-No. 502.0460.3041 (d_0 13)
Material-No. 502.0600.3041 (d_0 25)

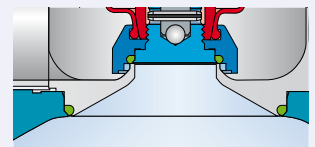

Test gag
J70: H2

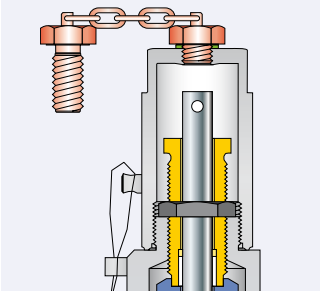

Lift indicator placed in bonnet
J38 + J93

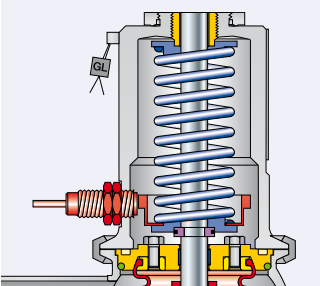

Special material

2.4610 HASTELLOY C4
2.4360 MONEL 400
1.4462 DUPLEX

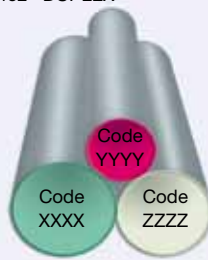

Type 485



Type 485
 Pneumatic lifting device H8
 Inlet: Integrated pipework connection Type 5034
 Outlet: Flange connection

Safety Relief Valves – spring loaded



Type 485
 Cap H2
 Inlet: Integrated pipework connection Type 5034
 Outlet: Welded end connection

Contents

Page

Materials

- HyTight Assembly 72

How to order

- Article numbers 74
- Available connections 75

Dimensions and weights

- Metric Units 76
- US Units 77

Pressure temperature ratings

- Metric Units + US Units 78

Selection chart H8 79

Surface quality 80

Approvals 81

Available options 82



Type 5034
 Integrated pipework connection

HyTight Assembly

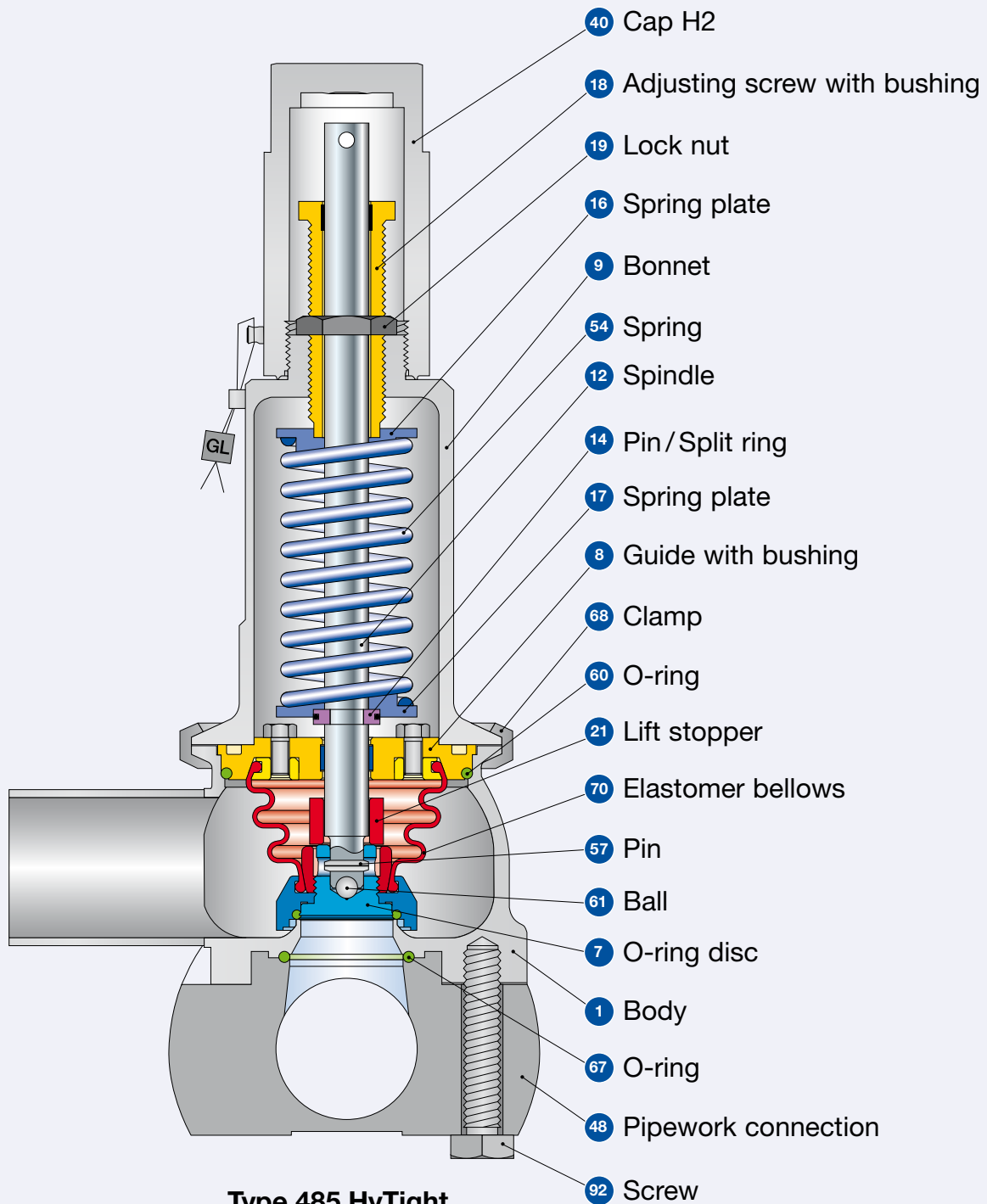

Type 485 HyTight
Cap H2

Inlet: Integrated pipework connection Type 5034
Outlet: Welded end connection

Materials		HyTight Assembly	
Item	Component	Remarks	Type 4854 HyTight
1	Body		1.4435 (BN 2) ^{*)} SA 479 316L
7	Disc	HyTight Assembly	1.4435 316L
7.4	Soft seal O-ring	"D" 	EPDM
		"C" 	FFKM
8	Guide with bushing	PTFE + 15 % glass	1.4435 316L
9	Bonnet		1.4404 316L
12	Spindle		1.4404 316L
14	Pin / Split ring		1.4310 / 1.4404 Stainless steel / 316L
16 / 17	Spring plate		1.4404 316L
18	Adjusting screw with bushing	PTFE + 15 % glass	1.4404 / PTFE 316L / PTFE
19	Lock nut		1.4404 316L
21	Lift stopper		1.4404 316L
40	Cap H2		1.4404 316L
54	Spring		1.4310 Stainless steel
57	Pin		1.4310 Stainless steel
60	O-ring		EPDM
61	Ball		1.4401 316
68	Clamp		1.4401 316
70	Elastomer bellows		EPDM
Integrated pipework connection Type 5034			
48	Pipework connection		1.4435 (BN 2) ^{*)} SA 479 316L
67	O-ring		EPDM
92	Screw		1.4401 316
-	Blind flange for pressure test		1.4404 316L

^{*)} The material 1.4435/SA 479 316L fulfils the requirements of the Swiss chemical and pharmaceutical industry Basler Norm (BN 2).

Please notice: – Modifications reserved by LESER.
 – LESER can upgrade materials without notice.
 – Every part can be replaced by other material acc. to customer specification.

Article numbers

Article numbers				
Actual Orifice diameter d_0 [mm]		13	25	
Actual Orifice area A_0 [mm ²]		133	491	
Actual Orifice diameter d_0 [inch]		0,512	0,984	
Actual Orifice area A_0 [inch ²]		0,206	0,761	
O-ring material		EPDM "D" J22	EPDM "D" J22	
		FFKM "C" J20	FFKM "C" J20	
Body material: 1.4435 (316L)				
Bonnet closed	H2	Art.-No. 4854.	7742	7752
	H4	Art.-No. 4854.	7744	7754
	H8	Art.-No. 4854.	7748	7758
		p [bar] S/G/L	0,3 – 16	0,1 – 16
		p [psig] S/G/L	4,4 – 232	1,5 – 232
Integrated pipework connection material: 1.4435 (316L)		Please order separately		
	DN	25	40	50
DIN 11850	Art.-No. 5034.	0991	0992	0993
ISO 2037	Art.-No. 5034.	0994	0995	0996
DIN EN ISO 1127	Art.-No. 5034.	0998	0999	-
Blind flange for pressure test: 1.4404 (316L)		Please order separately		
	Art.-No.	138.8949.9000	138.8749.9000	

Fitting information

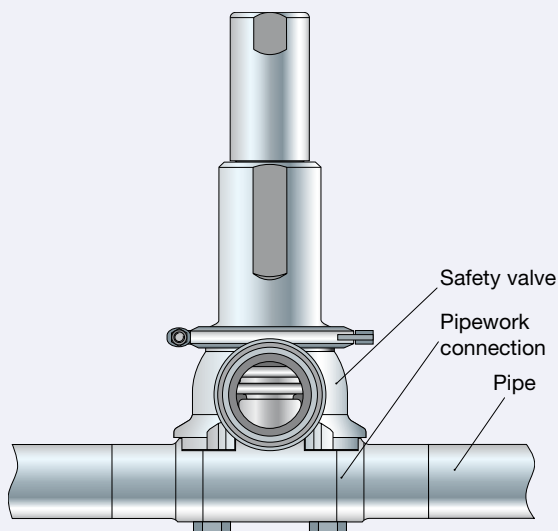

Type 5034
Installation: Integrated pipework connection, safety valve

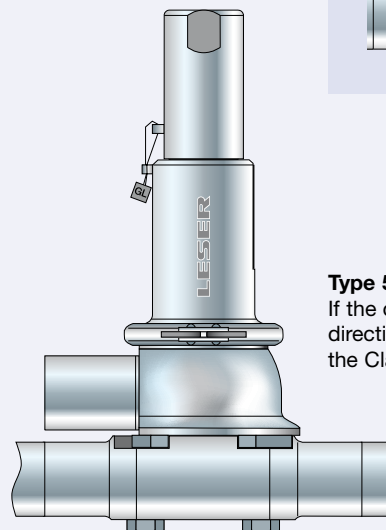

Type 5034
If the outlet has the same direction like the pipe, the Clamp is not possible

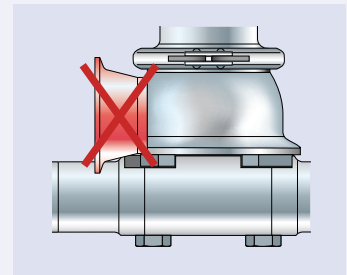

Available connections

Available connections

Clamps Option code inlet

For inlet please select integrated pipework connection Type 5034 as shown on page 74.

Aseptic screwed connection Option code inlet

Aseptic flanged connection Option code inlet

d _o [mm]	13	25
A _o [mm ²]	133	491

Clamps Option code outlet

DN	25	40
SO	L86A16	L86A17
DO	I74A16	I71A17
NPS	1 1/2"	2"
BO	I76A80	I76A81
CO	L97A80	L97A81

Aseptic screwed connection Option code outlet

Pipe standard	DN	25	40
DIN 11850 / DIN 11866 Range A	00	A85L83A16	A85L83A17
	GS	A85H35A16	A85H35A17
	BS	A85H37A16	A85H37A17
	GT	A85H55A16	A85H55A17
	BT	A85H57A16	A85H57A17
	GO	A85L81A16	A85L81A17
	KO	A85L82A16	A85L82A17
	GD	A85H61A16	A85H61A17
	BD	A85H59A16	A85H59A17

Pipe standard DN 25 40

DIN EN ISO 1127 / DIN 11866 Range B	GS	A86H35A16	A86H35A17
	BS	A86H37A16	A86H37A17
	GT	A86H55A16	A86H55A17
	BT	A86H57A16	A86H57A17
	GD	A86H61A16	A86H61A17
	BD	A86H59A16	A86H59A17

Pipe standard NPS 1 1/2" 2"

BS 4825-1 DIN 11866 Range C	GS	A84H35A80	A84H35A81
	BS	A84H37A80	A84H37A81
	GT	A84H55A80	A84H55A81
	BT	A84H57A80	A84H57A81

Aseptic flanged connection Option code outlet

Pipe standard	DN	25	40
DIN 11850 / DIN 11866 Range A	NF	A85H72A16	A85H72A17
	BF	A85H74A16	A85H74A17
	NG	A85H76A16	A85H76A17
	BG	A85H78A16	A85H78A17
	TN	A85L84A16	A85L84A17
	AF	A85L91A16	A85L91A17
	AN	A85L93A16	A85L93A17

Pipe standard DN 25 40

DIN EN ISO 1127 / DIN 11866 Range B	NF	A86H72A16	A86H72A17
	BF	A86H74A16	A86H74A17
	NG	A86H76A16	A86H76A17
	BG	A86H78A16	A86H78A17

Pipe standard DN 1 1/2" 2"

BS 4825-1 DIN 11866 Range C	NF	A84H72A80	A84H72A81
	BF	A84H74A80	A84H74A81
	NG	A84H76A80	A84H76A81
	BG	A84H78A80	A84H78A81

For definitions of connection codes please refer to pages 12 up to 15.

Dimensions and weights

Metric Units								
Actual Orifice diameter d_0 [mm]				25				
Actual Orifice area A_0 [mm ²]		133		491				
Integrated pipework connection				Inlet				
PN		16		16				
Nominal pipe size tube		DN		40		50		
Offset	c	[mm]	38	49		55		
Length	L	[mm]	130	180		180		
DIN 11850	Diameter	d	[mm]	42,4		54,5		
	Wall thickness	s	[mm]	2		2,25		
ISO 2037	Diameter	d	[mm]	39		52		
	Wall thickness	s	[mm]	2		2		
DIN EN ISO 1127	Diameter	d	[mm]	48,3		–		
	Wall thickness	s	[mm]	2,15		–		
Welded connections				Inlet a ¹⁾	Outlet b	Inlet a ¹⁾	Outlet b	
PN		16		16		16		
Center to face		[mm]	58	72	90	84	90	
Height – H4	H max.	[mm]	234	331		343		
Height – H8 double piston design	H max.	[mm]	262,2	338,7		350,7		
Clamp connections				Inlet a ¹⁾	Outlet b	Inlet a ¹⁾	Outlet b	
PN		16		16		16		
Center to face		[mm]	58	72	112	84	112	
Clamp diameter	d_{inner}	[mm]	For varying clamp diameters please refer to page 16 and 17					
	d_{outer}	[mm]						
Height – H4	H max.	[mm]	234	331		343		
Height – H8 double piston design	H max.	[mm]	262,2	338,7		350,7		
Threaded connections				Inlet a ¹⁾	Outlet b	Inlet a ¹⁾	Outlet b	
PN		16		16		16		
Center to face		[mm]	58	72	130	84	130	
Height – H4	H max.	[mm]	234	331		334		
Height – H8 double piston design	H max.	[mm]	262,2	338,7		350,7		
Flanged connections				Inlet a ¹⁾	Outlet b	Inlet a ¹⁾	Outlet b	
PN		16		16		16		
Center to face		[mm]	58	72	134	84	134	
Height – H4	H max.	[mm]	234	331		343		
Height – H8 double piston design	H max.	[mm]	262,2	338,7		350,7		
Weight				5,0				
Weight	max.	[kg]	3,0					

¹⁾ without integrated pipework connection

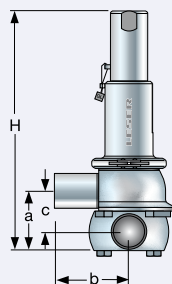

Type 485 – Cap H2

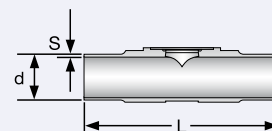

Type 5034 – Integrated pipework connection

Dimensions and weights

US Units							
Actual Orifice diameter d_0 [inch]		0,512				0,984	
Actual Orifice area A_0 [inch ²]		0,206				0,761	
Integrated pipework connection				Inlet			
		PN				16	
Nominal pipe size tube		NPS				1"	
Offset	c	[inch]				1 1/2"	
Length	L	[inch]				1 15/16	
DIN 11850	Diameter	d	[inch]			1 5/8	
	Wall thickness	s	[inch]			1/8	
ISO 2037	Diameter	d	[inch]			1 1/2	
	Wall thickness	s	[inch]			1/8	
DIN EN ISO 1127	Diameter	d	[inch]			1 7/8	
	Wall thickness	s	[inch]			1/8	
Welded connections				Inlet a ¹⁾		Outlet b	
		PN				16	
Center to face		[inch]		2 1/4		3 5/32	
Height – H4		H max. [inch]		9 7/32		13 1/2	
Height – H8 double piston design		H max. [inch]		10 5/16		13 11/32	
Clamp connections				Inlet a ¹⁾		Outlet b	
		PN				16	
Center to face		[inch]		2 1/4		4 1/32	
Clamp diameter		d _{inner} [inch]		For varying clamp diameters please refer to page 16 and 17			
		d _{outer} [inch]					
Height – H4		H max. [inch]		9 7/32		13 1/2	
Height – H8 double piston design		H max. [inch]		10 5/16		13 13/16	
Threaded connections				Inlet a ¹⁾		Outlet b	
		PN				16	
Center to face		[inch]		2 1/4		4 23/32	
Height – H4		H max. [inch]		9 7/32		13 1/2	
Height – H8 double piston design		H max. [inch]		10 5/16		13 13/16	
Flanged connections				Inlet a ¹⁾		Outlet b	
		PN				16	
Center to face		[inch]		2 1/4		4 31/32	
Height – H4		H max. [inch]		9 7/32		13 1/2	
Height – H8 double piston design		H max. [inch]		10 5/16		13 13/16	
Weight							
Weight		max. [lb]		6,6		11,0	

¹⁾ without integrated pipework connection

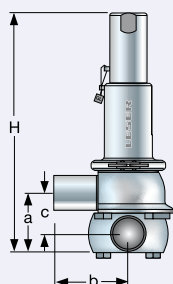

Type 485 – Cap H2

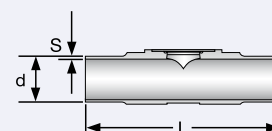

Type 5034 – Integrated pipework connection

Pressure temperature ratings

Metric Units					
Actual Orifice diameter d_0 [mm]		13	25		
Actual Orifice area A_0 [mm ²]		133	491		
Body material: 1.4435 (316L)					
Minimum set pressure	p [bar] S/G/L	0,3		0,1	
Maximum set pressure	p [bar] S/G/L	16		16	
Temperature range ¹⁾		Minimum	Maximum	Minimum	Maximum
EPDM	[°C]	-45	+150	-45	+150
FFKM	[°C]	0	+250	0	+250

US Units					
Actual Orifice diameter d_0 [inch]		0,512	0,984		
Actual Orifice area A_0 [inch ²]		0,206	0,761		
Body material: 1.4435 (316L)					
Minimum set pressure	p [psig] S/G/L	4,4		1,5	
Maximum set pressure	p [psig] S/G/L	232		232	
Temperature range ¹⁾		Minimum	Maximum	Minimum	Maximum
EPDM	[°F]	-49	+302	-49	+302
FFKM	[°F]	+32	+482	+32	+482

¹⁾ The temperature is limited by the soft seal material.

Selection chart H8

Depending on the set pressure and lifting pressure (air supply) a double piston lifting device (option code J41) may be required instead of a single piston. The chart below determines the required lifting device.

Selection chart lifting device H8, size 0. d_0 13 mm / 0,512 inch

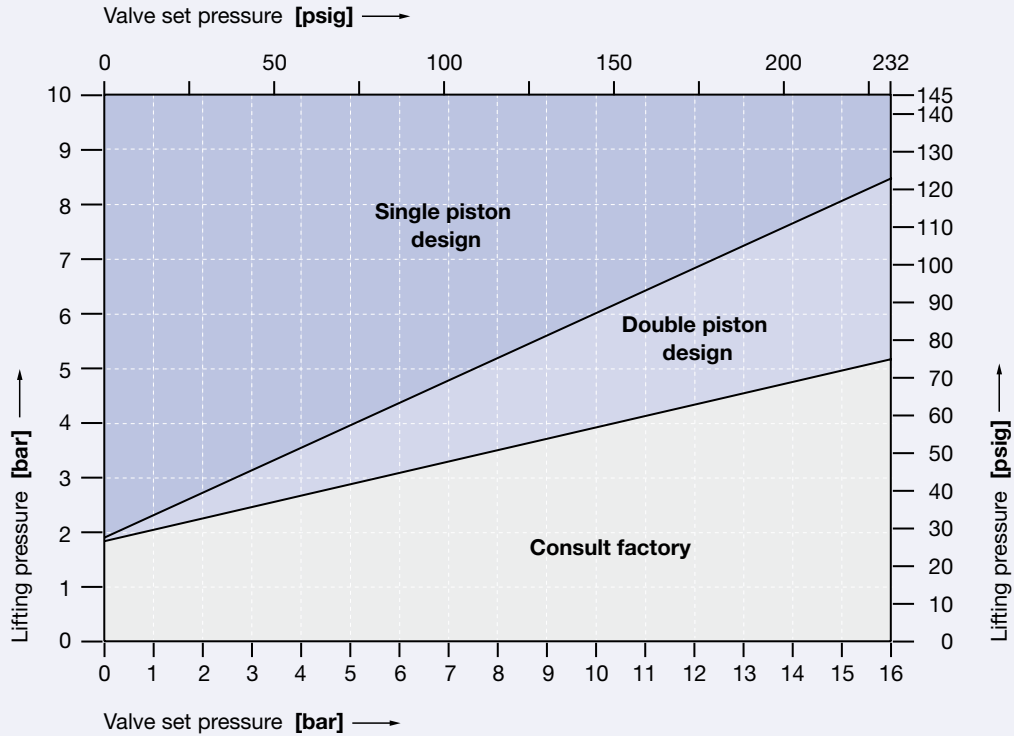

Selection chart lifting device H8, size I. d_0 25 mm / 0,984 inch

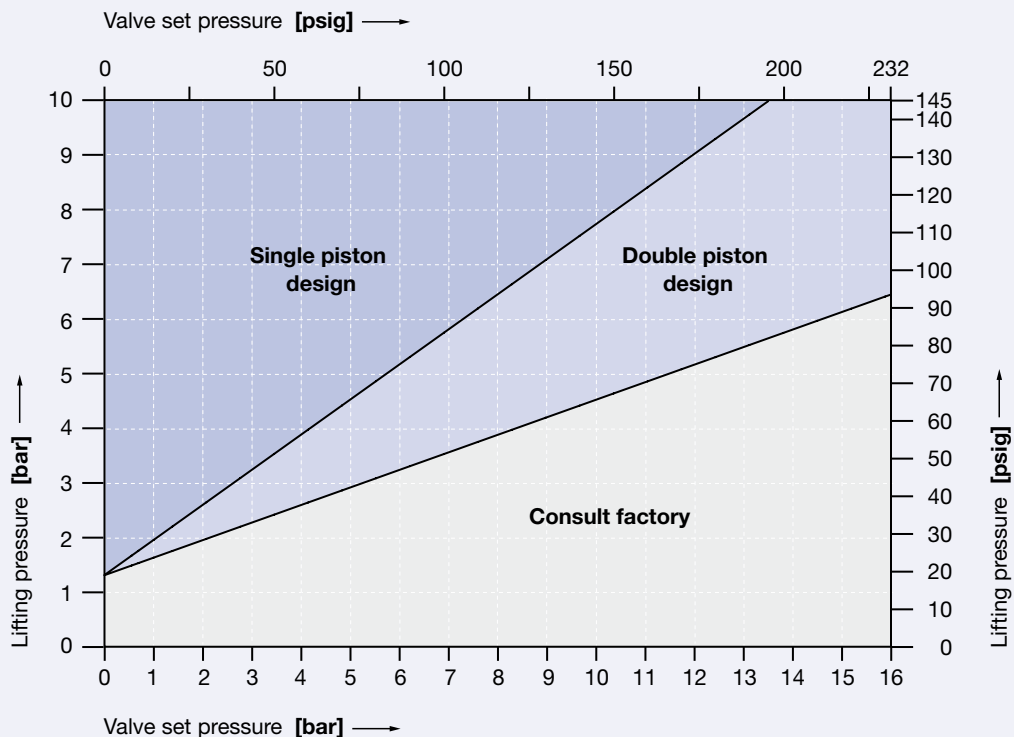

Surface quality

Surface quality			LESER Surface package			
Type of surface	Area		Option code	Clean finish	HyClean finish	Sterile finish
	Description	No.		B62	B63	B64
				R _a max.	R _a max.	R _a max.
LESER Surface grade						
Product contact surface	Inlet	1		ME4	ME2	ME1
			[µm]	0,750	0,500	0,375
	[µinch]	30	20	15		
Bottom side of disc	2		ME4	ME2	ME1	
		[µm]	0,750	0,500	0,375	
		[µinch]	30	20	15	
Blow off surface	Inside surface of outlet area	3		ME4	ME3	ME2
			[µm]	0,750	0,625	0,500
	[µinch]	30	25	20		
	Welding seam	4		ME6	ME5	ME4
[µm]			3,000	1,500	0,750	
[µinch]	120	60	30			
Outer surface	Outside surface of body, bonnet and cap/lifting device	5		ME5	ME4	ME4
			[µm]	1,500	0,750	0,750
[µinch]	60	30	30			
Shielded surface	Surface never in contact with the product because it is shielded by the bellows	6		No definition		

Type 5034

Integrated pipework connection

Type 5034			LESER Surface package			
Type of surface	Area		Option code	Clean finish	HyClean finish	Sterile finish
	Description	No.		B65	B66	B67
				R _a max.	R _a max.	R _a max.
LESER Surface grade						
Product contact surface	Pipework side	7		M4	M2	M1
			[µm]	0,750	0,500	0,375
			[µinch]	30	20	15
Outer surface	Outside surface	8		M5	M4	M4
			[µm]	1,500	0,750	0,750
			[µinch]	60	30	30

If required surface deviates from standard clean finish please specify option code and required LESER Surface package.

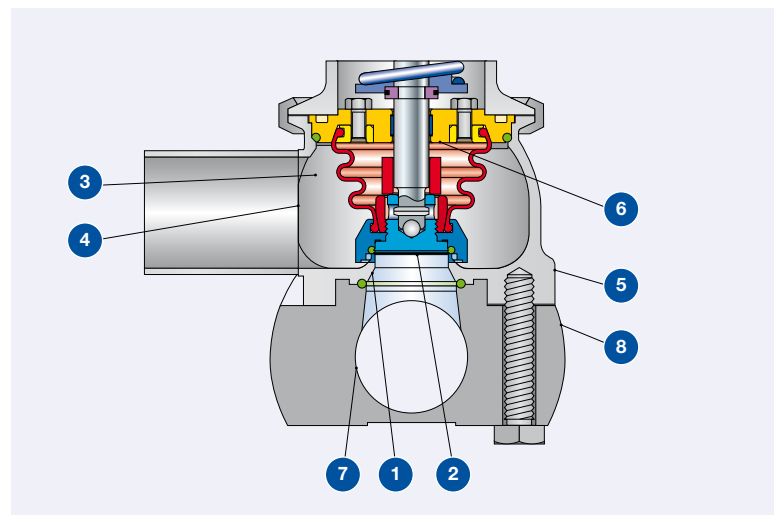

Approvals

Approvals			
Actual Orifice diameter d_0 [mm]		13	25
Actual Orifice area A_0 [mm ²]		133	491
Actual Orifice diameter d_0 [inch]		0,512	0,984
Actual Orifice area A_0 [inch ²]		0,206	0,761
Europe		Coefficient of discharge K_{dr}	
DIN EN ISO 4126-1	Approval No.	07 202 0111 Z 0008/0/20	
	S/G	0,58	0,4
	L	0,39	0,26
Germany		Coefficient of discharge α_w	
AD 2000-Merkblatt A2	Approval No.	TÜV SV 1047	
	S/G	0,58	0,4
	L	0,39	0,26
United States		Coefficient of discharge K	
ASME Sec. VIII	Approval No.	M37145	M37167
	S/G	Rated slope acc. to ASME VIII, Div. 1 UG-131 (d) (2) S: 5,52 lb / hr / psia Δ K \approx 0,521 G: 1,96 SCFM / psia Δ K \approx 0,521	Rated slope acc. to ASME VIII, Div. 1 UG-131 (d) (2) S: 13,97 lb / hr / psia Δ K \approx 0,357 G: 4,96 SCFM / psia Δ K \approx 0,357
	L	Rated slope acc. to ASME VIII, Div. 1 UG-131 (d) (2) L: 2,96 GPM $\sqrt{\text{psid}^*}$ Δ K \approx 0,379	Rated slope acc. to ASME VIII, Div. 1 UG-131 (d) (2) L: 7,46 GPM $\sqrt{\text{psid}^*}$ Δ K \approx 0,258
	Approval No.	M37156	M37178
	L	Rated slope acc. to ASME VIII, Div. 1 UG-131 (d) (2) L: 2,96 GPM $\sqrt{\text{psid}^*}$ Δ K \approx 0,379	Rated slope acc. to ASME VIII, Div. 1 UG-131 (d) (2) L: 7,46 GPM $\sqrt{\text{psid}^*}$ Δ K \approx 0,258
Canada		Coefficient of discharge K	
CRN	Approval No.	OG0772.9C	
	S/G	Rated slope acc. to ASME VIII, Div. 1 UG-131 (d) (2) S: 5,52 lb / hr / psia Δ K \approx 0,521 G: 1,96 SCFM / psia Δ K \approx 0,521	Rated slope acc. to ASME VIII, Div. 1 UG-131 (d) (2) S: 13,97 lb / hr / psia Δ K \approx 0,357 G: 4,96 SCFM / psia Δ K \approx 0,357
	L	Rated slope acc. to ASME VIII, Div. 1 UG-131 (d) (2) L: 2,96 GPM $\sqrt{\text{psid}^*}$ Δ K \approx 0,379	Rated slope acc. to ASME VIII, Div. 1 UG-131 (d) (2) L: 7,46 GPM $\sqrt{\text{psid}^*}$ Δ K \approx 0,258
China		Coefficient of discharge α_w	
AQSIQ	Approval No.	02301T	
	S/G	0,58	0,4
	L	0,39	0,26
Eurasian Custom Union		Coefficient of discharge α_w	
EAC	Approval No.	For current approval no. see www.leser.com	
	S/G	0,58	0,4
	L	0,39	0,26
Classification societies			
on request			

*_d psid = Differential pressure P-P_d
P = absolute flow pressure [psia]
P_d = pressure at discharge from valve [psia]

Available options

Gastight cap H2
H2

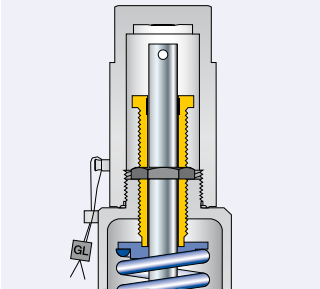

Gastight lifting device H4
Packed knob H4

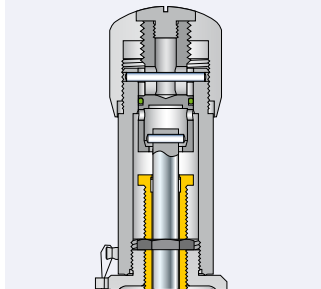

Pneumatic lifting device H8
H8 single piston design

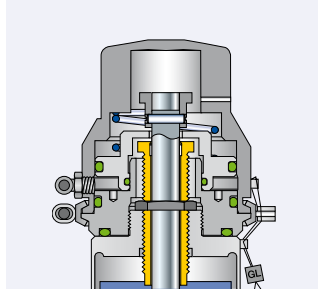

Pneumatic lifting device H8
J41: H8 double piston design

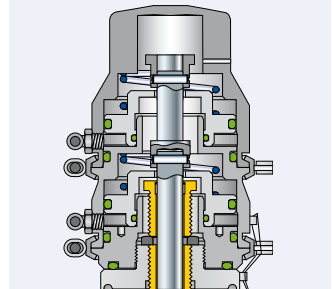

O-ring-disc

J22: EPDM "D"
J20: FFKM "C"

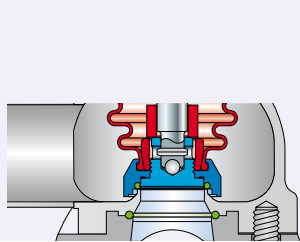

Bellows FFKM "C"

S70 – only for d₀13

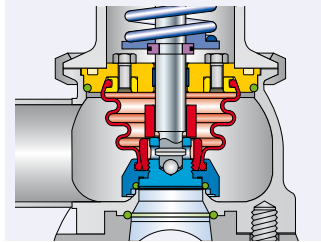

Blind flange for pressure test

Material No. 138.8949.9000 (d₀ 13)
Material No. 138.8749.9000 (d₀ 25)

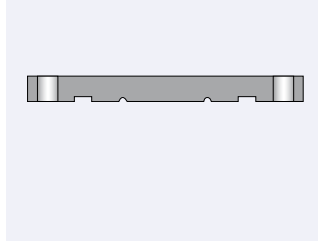

O-ring for integrated pipework connection

EPDM "D"
Material No. 502.0180.3041 (d₀ 13)
Material No. 502.0300.3041 (d₀ 25)

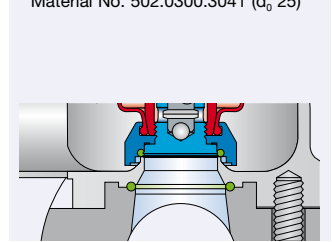

Test gag
J70: H2

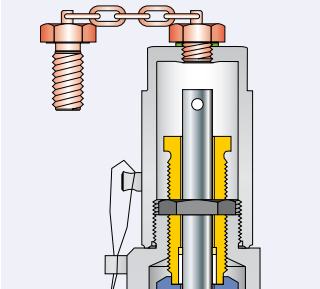

Lift indicator placed in bonnet
J38 + J93

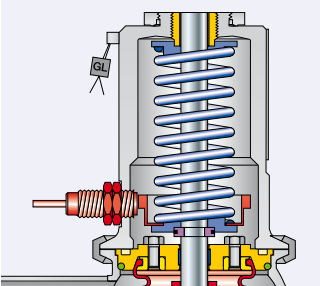

Special material

2.4610 HASTELLOY C4
2.4360 MONEL 400
1.4462 DUPLEX

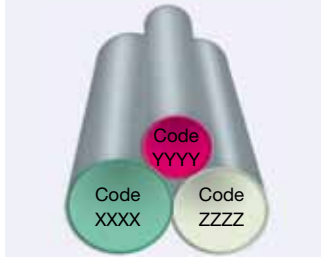

LESER worldwide

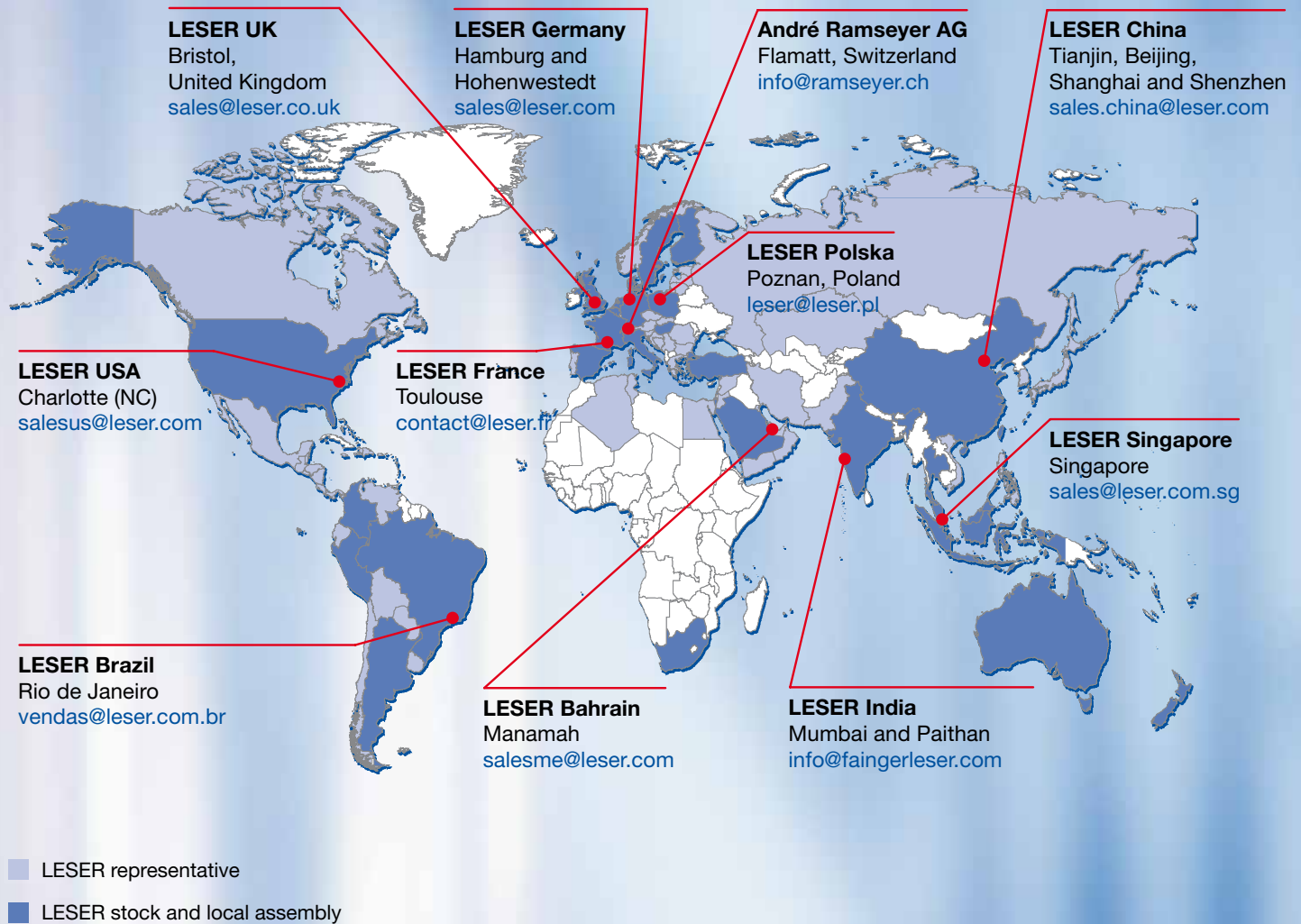

Clean Service Catalog
Edition July 2014
0777.5477

LESER

The-Safety-Valve.com

LESER GmbH & Co. KG

20537 Hamburg, Wendenstr. 133-135
20506 Hamburg, P.O. Box 26 16 51

Fon +49 (40) 251 65-100
Fax +49 (40) 251 65-500

E-mail: sales@leser.com
www.leser.com